



宁波九隆五金有限公司  
NINGBO JIULONG HARDWARE CO.LTD



## SNOW CHAIN CATALOGUE 2017



BE WITH US, BE WITH SAFETY!

Office ADD: Room 506-509 No.1357YINXIAN street, Ningbo, China.

Factory Add: No. B-8 Technology park, Ningbo, China.

TEL: 0086-574-82815295

FAX: 0086-574-82815296

Mobile: 0086-13989392999

P.C: 315100

EMAIL: SALES@JLHARDWARE.COM

Website: WWW.NB-JIULONG.COM

WWW.NB-JIULONG.CN

WWW.JLHARDWARE.COM





## COMPANY PROFILE

NINGBO JIU LONG HARDWARE CO.,LTD. is a group company which owns two other subsidiaries: Zhejiang Jin Long Machinery Rigging CO.,LTD. and Ninghai Shuanggen Rubber &Plastic Co.,Ltd. It is located in Ninghai High-tech Industrial park Ningbo city--well- know as eastern pearl of China with beautiful sight-seeing. As the park is just near to the express way and main road, the transportation here is very convenient with Ning Bo international airport, Beiluo port just nearby.

Our services cover designing, manufacturing and sales of cargo control product, lifting and lashing hardware , truck parts, trailer products, supermarket shelves and shopping carts, machinery and riggings. There are over 400 0 products , among them 25 have got national patent. Owing to our refined design, original appearance and excellent workmanship, our products are now popular in over ten countries and areas like the United States, Germany, UK, France, the Netherland, Poland, Mexico and Taiwan etc.

For years, we have been the manufacturing company in our areas and have won the titles as city is "Contract stressed and credit reliable" company, AAA credit ranking company, we also got Achievement Award from intertek for WCA(Workplace Conditions Assessment)

Our fixed asset is over RMB 250million (USD40million) and the company covers over 100,000 square meters with buildings of 80000 square meters. Totally we have 1100 employees, 120 of them are junior and senior engineers, 150 are skilled technicians, we total have 3 big plant base on different product range.

Here following are the main equipment we have:

Imported auto chrome-painting line	2 EA
Imported auto powder-painting line	4 EA
Imported auto zinc-painting line	6 EA
Imported threading-drawing machine	4 EA
Imported alignment machine	20 EA
Imported spot-welding machine	40 EA
Imported robot welding machine	6 EA
Imported bending machine	4 EA
Mould finish-machining equipment	30 EA
100T-500T Hydraulic press Machine	10 EA
Large scale Hydraulic plate-cutting machine	2 EA
5T-250T Punch machine	60 EA
160T-1000T friction press	30 EA
Forging machine(from 400T to 1200T)	12 EA
Imported Webbing sewing machine	20 EA
webbing stitching machine	30 EA
Testing machine	6 EA

We are rapidly growing into a high-tech manufacturing company specialized in the production of argo control product, lifting and lashing hardware , truck parts, trailer products, supermarket shelves and shopping carts, machinery and riggings. series products with our advanced equipment, high efficiency stuffs, aggressive R & D and strong exploring spirit.

We can not only design and make all kinds of products within our product lines, we have set up an overall quality-control system from the raw material to finished products also. This enables us to pass ISO9001 and ISO 14000 approval.

We always hold our company idea "result-oriented, innovation, hard-working and surpassing" and this brings our unique company culture as "frank behaving, steady working, aggressive exploring and life-long studying" and our operation principle as "Innovation, sincere service, credit-stressing and supreme-quality".

We'd like to provide our customers with products of big variety, high quality and attractive appearance.

# INDEX

A Car Chains

B Jeep Chains

C Garden & ATV Chains

D Truck Chains

E Tractor & Forest Chains

F Accessories

G Tech Guide

H Other Winter Items

# A



## Car Chains

<b>A1</b>	<b>QD Series</b>	P.4-5
<b>A2</b>	<b>KN Series</b>	P.6-7
<b>A3</b>	<b>KNN Series</b>	P.8
<b>A4</b>	<b>KND Series</b>	P.9
<b>A5</b>	<b>KL Series</b>	P.10
<b>A6</b>	<b>Y Series</b>	P.11
<b>A7</b>	<b>V Series</b>	P.12
<b>A8</b>	<b>H Series</b>	P.13
<b>A9</b>	<b>VI / V2 Series</b>	P.14

<b>A10</b>	<b>V3 Series</b>	P.15
<b>A11</b>	<b>AG Series</b>	P.16
<b>A12</b>	<b>TL Series</b>	P.17
<b>A13</b>	<b>10 / 19 CABLE Series</b>	P.18-19
<b>A14</b>	<b>15 Series</b>	P.20-21
<b>A15</b>	<b>PL &amp; PLE Series</b>	P.22-23
<b>A16</b>	<b>12 / 18 Series</b>	P.24-25

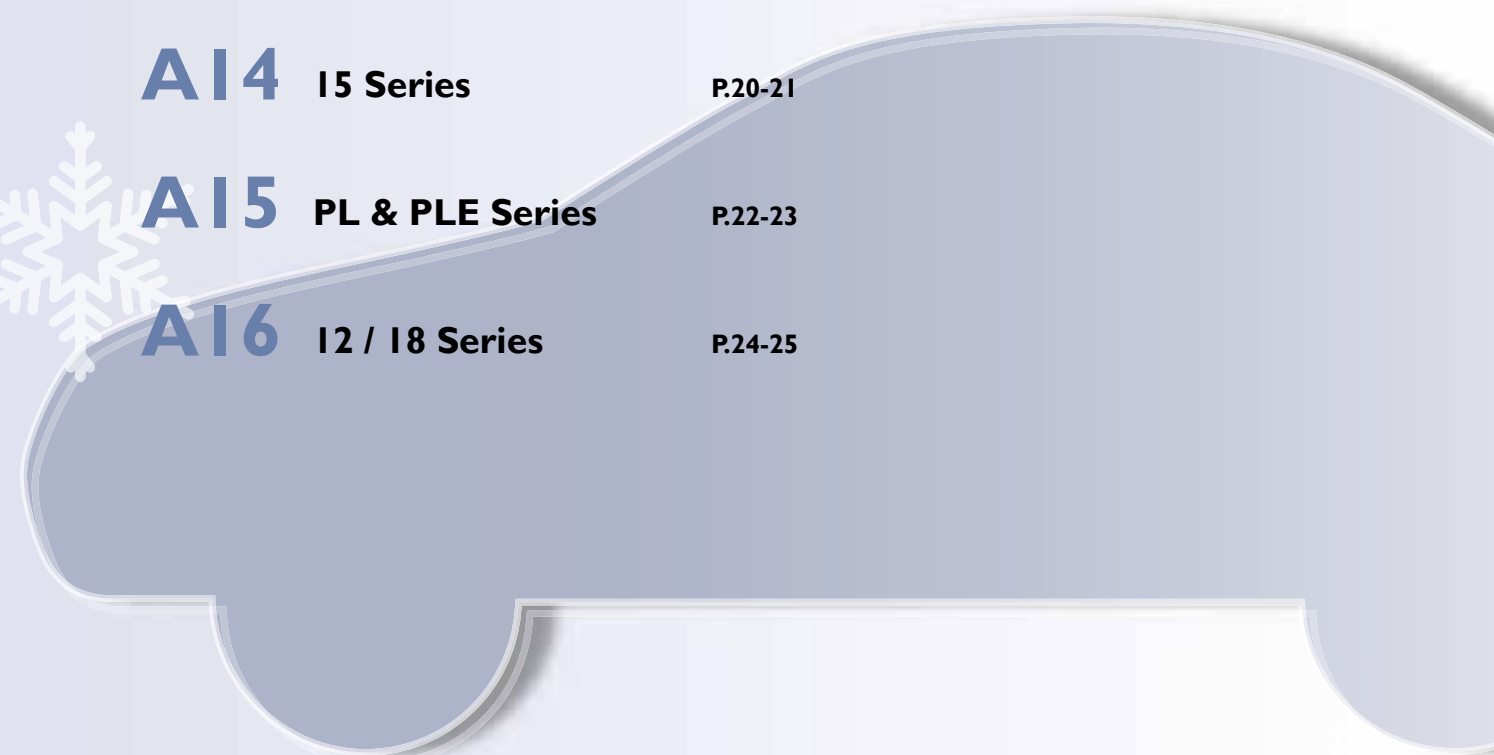



# AI QD series

**NEW!!**



**PATENT PROTECTED**

## 3 Second Dismounting

- Diamond tire chains pattern insures a comfortable drive with less vibration and noise.
- Maximum traction with minimal brake distance and skidding.
- The small square links and the short length of each cross chain minimizes wear and breakage.
- Easily operated chain tensioning system
- Fitted in minutes, without the need to jack up, or move the car
- With new quick dismounting system, to dismount the snow chains takes just seconds!
- Unique "D" type square link design, gaining excellent traction.
- Flexible steel cable covered with plastic sheath.
- Thermal treated electro-galvanised chains
- Elegant and strong plastic case, safe and convenient, spacesaving.
- Comes complete with installation instructions, repair links 1 pair/case
- With new fastening system, it's no longer necessary to stop the car and re-fasten the chains after mounting. Just mount and go, so easy!

### Mounting Steps

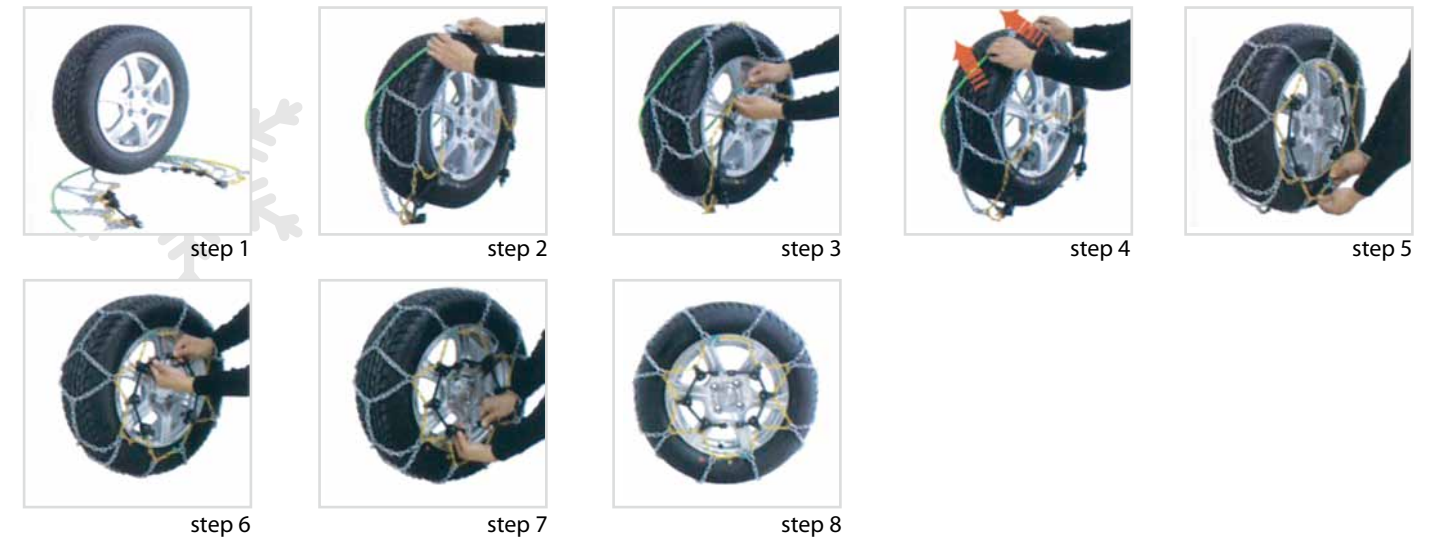

### Dismounting Steps

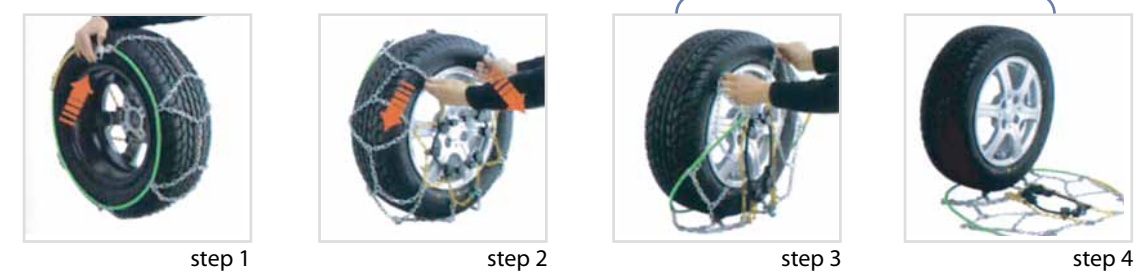

# A2 KN series



- Diamond tire chains pattern insures a comfortable drive with less vibration and noise.
- Maximum traction with minimal brake distance and skidding.
- The small square links and the short length of each cross chain minimizes wear and breakage.
- Easily operated chain tensioning system
- Fitted in minutes, without the need to jack up, or move the car
- Unique "D" type square link design, gaining excellent traction.
- Flexible steel cable covered with plastic sheath.
- Thermal treated electro-galvanised chains
- Elegant and strong plastic case, safe and convenient, spacesaving.
- Comes complete with installation instructions, repair links 1 pair/case

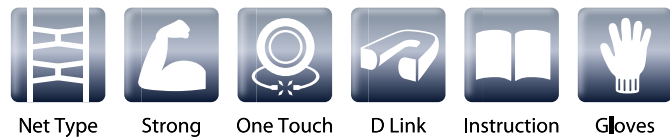

Tire Size Table For Car Chains QD KN KNN KND KL Y V H V1 V2 V3

Item No.	Tire Sizes										
10	165/70-10	155/80-10	145-10	155-10	145/80-10	120/80-10	140/70-12	125-12	135-12	145/70-12	400-12
20	145-12	145/80-12	155/70-12	165/55-13	135-13	135/80-13	145/70-13	155/65-13	165/60-13	175/50-13	150/65-340
30	155-12	560-12	600-12	165/70-12	175/70-12	145-13	145/80-13	155/70-13	165/65-13	175/60-13	185/55-13
40	135-14	155/60-14	165/60-14	155/65-14	175/50-14	160/65-340	185/65-315	155/80-12	145/70-14	135/80-14	135/70-15
45	175/60-14	155/65-15	185/55-14								
50	165-13	170-13	560-13	590-13	165/80-13	175/70-13	185/65-13	170/65-365	520-14	560-14	165/70-14
60	175-13	640-13	175/80-13	185/70-13	195/65-13	205/60-13	165-14	165/75-14	175/70-14	185/65-14	190/60-14
65	185/70-14	185/60-15	215/40-16	205/55-14	195/55-15	205/50-15					
70	185-13	185/80-13	195/70-13	205/65-13	175-14	175/75-14	185/70-14	195/65-14	205/60-14	175/70-15	185/65-15
80	195/55-15	205/50-15	195/60-15	205/45-16	180/65-390	200/55-390	175/80-14	600-13	215/40-16	195/50-16	205/40-17
90	205/70-13	185-14	195/70-14	205/65-14	175-15	185/70-15	195/65-15	205/55-15	215/50-15	215/40-17	190/65-390
95	200/60-390	210/55-390	205/60-15	210/65-365	220/55-365	185/80-14	175/80-15	205/50-16	195/55-16	195/60-16	205/45-17
100	195-14	205/70-14	225/55-14	225/60-14	185-15	195/70-15	205/65-15	215/60-15	225/50-15	225/55-15	205/55-16
110	225/45-16	205/60-16	215/50-16	205/50-17	195/75-14	600-14	195/75-15	195/80-14	235/40-17	195/65-16	215/45-17
120	235/60-14	195/75-15	205/65-16	215/50-17	205/70-15	215/55-16	225/45-17	215/65-15	245/40-17	225/60-15	235/55-15
130	225/50-16	205-14	215-14	195-15	205/70-15	215/65-15	225/60-15	235/55-15	890-15	215/55-16	225/50-16
140	215/50-17	225/45-17	225/55-390	230/55-390	240/55-390	240/45-415	255/45-15	225/70-14	600-15	650-14	205/80-14
150	235/60-14	205/65-16	215/70-14	245/45-16	225/45-18	225/40-18					
160	215/70-15	225/65-15	215/60-16	225/55-16	235/55-16	225/50-17	235/45-17	245/40-17	235/40-18	220/65-390	235/40-475
170	235/60-15	235/50-17									
180	225/70-15	215/65-16	235/60-16	225/60-16	245/45-18	265/35-18	245/45-17	225/55-17	215/70-16	245/40-18	255/40-17
190	245/60-15	245/55-16	255/50-16	235/55-17	245/50-17	275/40-17	255/40-18	255/45-17	225/60-17		

Item	Sizes	Item	Sizes	Item	Sizes	Item	Sizes	Item	Sizes
10	120/80	60	175/80	100	205	90	225/55	130	245/50
10	145	70	185	60	205/55	100	225/60	120	255/40
10	145/80	30	185/55	70	205/60	110	225/65	130	255/45
10	155	40	185/60	80	205/65	120	225/70	130	275/40
10	155/80	50	185/65	90	205/70	100	235/55	100	225/40
10	165/70	60	185/70	100	205/80	110	235/60	100	225/45
10	500	70	185/80	100	215	130	245/60	110	235/40
10	125	40	195/55	100	215/70	100	255/45	120	245/40
10	125/80	50	195/60	90	225/55	60	560	120	245/45
10	130/80	60	195/65	90	225/60	100	600	130	255/40
10	135	70	195/70	100	225/70	100	890	120	265/35
20	135/80	60	205/60	100	235/60	60	185/50	20	160/60
10	140/70	70	205/65	50	520	60	195/45	20	160/65
20	145	80	205/70	50	560	70	195/50	30	185/65
10	145/70	50	560	90	600	80	195/55	20	150/65
20	145/80	50	590	100	650	80	195/60	30	160/65
20	150	70	600	40	125	90	195/65	40	170/65
10	150/65	60	640	40	135	70	205/45	40	180/60
30	155	30	135	30	135/70	80	205/50	50	180/65
20	155/70	30	135/80	50	145	90	205/55	50	190/55
30	155/80	40	145	60	155	90	205/60	50	190/65
20	165/60	30	145/70	50	155/65	100	205/65	60	200/65
30	165/70	40	145/80	50	155/70	70	215/40	20	150/65
30	175/70	50	155	60	165/70	90	215/50	40	160/65
10	400	30	155/60	50	170/60	100	215/55	50	170/65
20	500	30	155/65	80	175	110	215/60	60	180/65
30	560	40	155/70	50	175/55	120	215/65	50	190/55
30	600	50	155/80	60	175/60	120	215/70	60	190/60
10	125	60	165	60	175/65	90	225/45	60	195/60
20	135	30	165/60	70	175/70	100	225/50	70	200/60
10	135/70	40	165/65	80	175/80	110	225/55	70	210/55
20	135/80	50	165/70	90	185	120	225/60	80	210/65
30	145	60	165/75	60	185/55	100	235/50	80	220/55
10	145/60	60	165/80	60	185/60	110	235/55	70	180/65
20	145/65	70	175	70	185/65	120	235/60	80	190/65
20	145/70	30	175/50	80	185/70	100	245/45	70	200/55
30	145/80	40	175/60	100	195	130	245/55	80	200/60
40	155	50	175/65	50	195/45	130	255/50	80	210/55
20	155/60	60	175/70	60	195/50	70	205/40	100	220/55
20	155/65	70	175/75	70	195/55	80	205/45	110	220/65
30	155/70	70	175/80	70	195/60	90	205/50	100	230/55
40	155/80	80	185	80	195/65	80	215/40	100	240/55
50	165	40	185/55	90	195/70	90	215/45	100	240/45
20	165/55	50	185/60	90	195/75	100	215/50	110	235/40
20	165/60	60	185/65	70	205/50	100	225/45		
30	165/65	70	185/70	80	205/55	110	225/50		
40	165/70	80	185/80	80	205/60	120	225/55		
50	165/80	60	190/60	90	205/65	130	225/60		
50	170	90	195	100	205/70	90	235/40		
60	175	50	195/55	80	215/50	110	235/45		
20	175/50	70	195/65	90	215/60	110	235/50		
30	175/60	80	195/70	100	215/65	130	235/55		
40	175/65	90	195/75	110	215/70	110	245/40		
50	175/70	90	195/80	90	225/50	120	245/45		



# A3 KNN series



- Diamond tire chains pattern insures a comfortable drive with less vibration and noise.
- Even lower Profile (9 mm projection). Especially good for today's down-sized cars. They can be used for modern vehicles with very limited clearance.
- Maximum traction with minimal brake distance and skidding.
- The small square links and the short length of each cross chain minimizes wear and breakage.
- Easily operated chain tensioning system
- Fitted in minutes, without the need to jack up, or move the car.
- Unique "D" type square link design, gaining excellent traction.
- Flexible steel cable covered with plastic sheath.
- Thermal treated electro-galvanised chains
- Elegant and strong plastic case, safe and convenient, spacesaving.
- Comes complete with installation instructions, repair links 1 pair/case

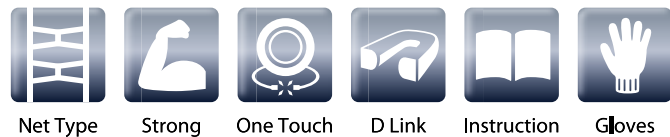

# A4 KND series



- Diamond tire chains pattern insures a comfortable drive with less vibration and noise.
- Maximum traction with minimal brake distance and skidding. Especially good for ice road driving.
- The small square links and the short length of each cross chain minimizes wear and breakage.
- Easily operated chain tensioning system
- Fitted in minutes, without the need to jack up, or move the car.
- Unique "D" type square link design, gaining excellent traction.
- Flexible steel cable covered with plastic sheath.
- Thermal treated electro-galvanised chains
- Elegant and strong plastic case, safe and convenient, spacesaving.
- Comes complete with installation instructions, repair links 1 pair/case.
- Specially strengthened with the Help of additional link Gaining excellent traction.
- Elegant and beautiful black bag for package as the other choice besides plastic box.



## Mounting Steps





# A5 KL series



- Ladder type tire chains pattern makes chains of less weight, easy installation.
- Easily operated chain tensioning system
- Fitted in minutes, without the need to jack up, or move the car.
- Unique "D" type square link design, gaining excellent traction.
- Flexible steel cable covered with plastic sheath.
- Thermal treated electro-galvanised chains
- Elegant and strong plastic case, safe and convenient, spacesaving.
- Comes complete with installation instructions, repair links 1 pair/case



# A6 Y series



- Y type tire chains pattern insures a comfortable drive with less vibration and noise.
- Easily operated chain tensioning system
- Fitted in minutes, without the need to jack up, or move the car.
- Unique "D" type square link design, gaining excellent traction.
- Flexible steel cable covered with plastic sheath.
- Thermal treated electro-galvanised chains
- Elegant and strong plastic case, safe and convenient, spacesaving.
- Comes complete with installation instructions, repair links 1 pair/case

## Mounting Steps



step 1



step 2

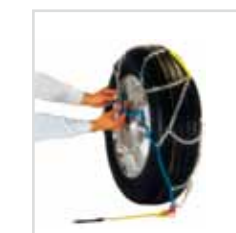

step 3



step 4

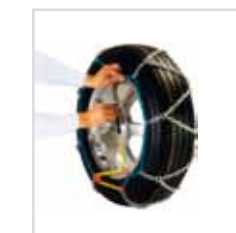

step 5



PACKAGE: 1 PAIR PER CASE

# A7 V series



- V type tire chains pattern insures a comfortable drive with less vibration and noise.
- Easily operated chain tensioning system
- Fitted in minutes, without the need to jack up, or move the car.
- Unique "D" type square link design, gaining excellent traction.
- Flexible steel cable covered with plastic sheath.
- Thermal treated electro-galvanised chains
- Elegant and strong plastic case, safe and convenient, spacesaving.
- Comes complete with installation instructions, repair links 1 pair/case

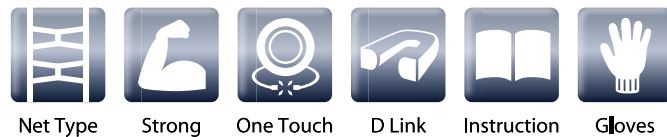

# A8 H series



- H type tire chains pattern insures light weight, as a result very easy installation.
- Easily operated chain tensioning system
- Fitted in minutes, without the need to jack up, or move the car.
- Unique "D" type square link design, gaining excellent traction.
- Double side flexible steel cable covered with plastic sheath.
- Thermal treated electro-galvanised chains
- Packaged in an elegant plastic bag.
- Comes complete with installation instructions, repair links.

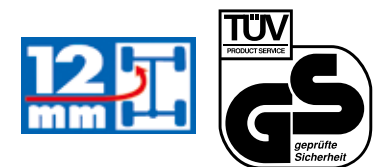



# A9 VI / V2 series



- "D" type square link, gaining excellent traction.
- Yellow galvanizing of cross chains, anti-wearing and attractive.
- Fastening with rubber ring & hook safer and more reliable.
- Thermal treated electro-galvanised chains
- Elegant and strong plastic case, safe and convenient, spacesaving.
- Comes complete with installation instructions, repair links.

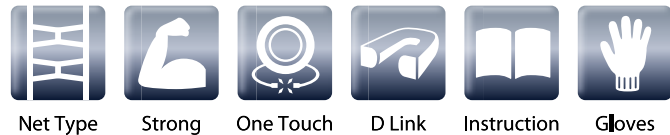

# A10 V3 series



- V3 type tire chains net pattern insures a comfortable drive with less vibration and noise.
- Easily operated chain tensioning system
- Fitted in minutes, without the need to jack up, or move the car.
- Unique "D" type square link design, gaining excellent traction.
- Thermal treated electro-galvanised chains
- Elegant and strong plastic case, safe and convenient, spacesaving.
- Comes complete with installation instructions, repair links.





# AG series



- Long life Chain made of PU, times as long as the common steel chains life.
- Hi-tech alloy spikes assure perfect traction.
- Attached to tire tread as tight as possible, less noisy, more calmful drive than ever.
- Color Box Package.



**Tire Size Table of AG Series**

Item No.	Tire Sizes			
AG-20	135/80-12 155/60-13	145/70-12	155/70-12	145/65-13
AG-21	145/80-12	135/80-12	155/65-13	165/60-13
AG-22	145/80-13 175/60-13	165/70-12	155/70-13	165/65-13
AG-23	155/80-13 185/65-13	165/80-13 165/65-14	165/70-13 175/60-14	175/70-13
AG-24	165/80-14 185/65-14	185/70-13 185/60-14	175/70-14	175/65-14
AG-25	175/80-13 205/60-14	185/70-14 195/55-15	195/65-14	195/60-14
AG-26	175/80-14 185/65-15	185/80-14 195/65-15	195/70-14 195/60-15	205/65-14 205/55-15
AG-27	175/80-15 205/65-15 205/55-16	205/70-14 205/60-15	195/70-15 215/60-15	215/65-14 215/55-15
AG-28	175/80-16	205/70-15	215/65-15	215/55-16
AG-29	215/70-15	215/60-16		

# TL series



- Long life Chain made of PU, times as long as the common steel chains life.
- Hi-tech alloy spikes assure perfect traction.
- Attached to tire tread as tight as possible, less noisy, more calmful drive than ever.
- Color Box Package.

**Tire Size Table of TL Series**

Item No.	Tire Sizes			
TL-1	145-10	5.20-10		
TL-2	135-12	145/70-12	5.00-10	5.65-12
TL-3	145-12 155/60-13	135-13	155/70-12	145/65-13
TL-4	155-12 165/65-13	145-13 5.00-12	165/70-12 6.00-12	155/70-13 145-12
TL-5	155-13 6.15-13	165/70-13 Y78-13	175/65-13	175/60-13
TL-6	165-13 5.60-13	175/70-13 175/65-14	165/65-14	175/60-14
TL-7	185/70-13 185/60-14	185/65-13 195/55-14	175/65-14 5.50-13	195/60-13 6.45-13
TL-8	175-13 185/65-14 185/70-13	165-14 195/60-14	195/70-13 195/50-15	175/70-14 6.45-14
TL-9	175-14	185/70-14	195/65-14	195/55-15
TL-10	185-14 6.95-14	195/70-14 6.40-14	185/65-14 185/70-14	195/60-15
TL-11	195-14 6.00-14	185/70-15 185-14	195/65-15	205/60-15
TL-12	205/70-14 215/55-15	195/70-15 205/55-16	205/65-15	215/60-15



# A13 10/19 series



- 10/19 series cable snow chains are designed for use on passenger cars. Especially those with limited wheel well clearance requiring SAE class "S" tire chain. Cable allows increased tire-to-road contact.
- Tire chains are designed for use on original equipment with highway type tread.
- It can also be used on radial and/or bias tires.



## Tire Size Table of 10 / 19 Car Chains

Item No.	Tire Sizes		
1014 1914	6.00-12; 145R12; 155R12; 165/70R12; P175/70R12; P145/80R12; P155/80R12;  135R13; 145R13; 155R13; P155/80R13; P165/60R13; P175/60R13; P185/65R13; P165/70R13; P165/75R13; P145/80R13	135R14 145R14 P165/60R14 P155/65R14 P145/70R14	135R15 P155/80R15
1018 1918	165R13; P215/50R13; P185/60R13; P165/65R13; P165/70R13; P175/70R13; P175/75R13; P165/80R13	6.00-14LT; P165/70R365; P185/55R14; P175/60R14; P185/60R14; P165/65R14; P175/65R14; P155/70R14; P165/70R14; P165/70R14; 155R14; P165/75R14;	145R15 P145/70R15 P155/70R15 P145/80R15 P165/70R360 P165/70R365
1022 1922	P175/80R13	175R14 P195/55R14 P175/75R14 P175/80R14	5.60-15; 155R15; 165R15 P185/55R15; P195/55R15 P185/60R15; P195/60R15 P185/65R15; P165/65R15 P165/70R15; P175/70R15 P155/80R15
1026 1926	175R13; 185R13; P195/60R13; P205/60R13; P215/60aR13; P195/65R13; P185/70R13; P195/70R13; P185/75R13; P185/80R13	165R14; P205/55R14; P195/60R14; P205/60R14; P185/65R14; P195/65R14; P175/ 70R14; P185/70R14; P185/75R14; P195/55R14;	P220/45R15; P195/50R15 P205/50R15; P185/60R15 P175/70R15; P185/65R15 P185/65R365; P195/70R15 P195/65R390; P195/65R15
1030 1930	195R13 P215/65R13 P205/70R13 P185/85R13	7.00-14LT; 185R14 P215/60R14; P225/60R14 P205/65R14; P195/70R14 P185/80R14; P195/75R14	7.00-15; 175R15 P225/50R15; P225/60R15 P190/65R15; P205/60R15 P205/65R15; P185/70R15 P185/70R365; P195/70R15 P195/65R390; P195/65R15
1034 1934	P235/50R13 P245/50R13	195R14; 205R14 P245/50R14; P225/55R14 P225/60R14; P235/60R14 P225/65R14; P205/70R14 P205/75R14; P215/75R14	185R15; 195R15; P205/55R15; P205/60R15; P215/60R15; P225/60R15; P205/65R15; P205/70R15; P195/70R15; P205/75R15; P195/80R15; P225/45R16; P205/50R16; P215/55R16; P235/55R16; P225/60ZR16; P205/55ZR16; P205/60ZR16; P215/45R17
1038 1938		205R14; 215R14 P245/60R14; P225/55R14 P225/70R14; P235/70R14 P225/75R14	7.75-15; 205R15; 215R15 P285/40R15; P245/50R15; P235/60R15; P215/65R15; P220/65R390; P215/70R15; P225/70R15; P215/75R15; P245/45ZR16; P245/50ZR16; P225/55R16; P215/60ZR16; P225/60ZR16; P205/65R16; P245/40ZR17; P255/40ZR17; P235/45R17; P245/45ZR17
1042 1942		225R14 P265/60R14 P275/60R14 P245/70R14 P265/50R14	8.55-15; 215R15; 225R15; 230R15; P265/50R15; P275/50R15; P295/50R15; P245/60R15; P255/60R15; P265/60R15; P255/65R15; P235/70R15; P245/70R15; P255/70R15; P225/75R15; P235/75R15; P225/80R15; P255/50ZR16; P265/50R16; P235/60ZR16; P245/60R16; P285/35ZR17; P275/40ZR17; P275/35ZR18; 235R15;
1046 1946			P265/75R15 P225/70R15 P275/60R15





# A14 15 series



**ALLOY STEEL**

- Diamond tire chains pattern insures a comfortable drive with less vibration and noise.
- Recommended for class "S" cars and abs systems
- Recommended for front-wheel drive
- Recommended for emergency vehicles
- Fitted in minutes, without the need to jack up, or move the car.



## Tire Size Table of 15 Series

Stock No.	Tire Sizes			
	12" & 13" Rims	14" Rims	15" Rims	16" and other Rims
1505	145R-12 P145/80R-12 155R-12 P165/70R-12			
1510	145R-13 P145/80R-13 P155/70R-13 P165/65R-13 P165/70R-13			
1515	155R-13 P155/80R-13 175/60R-13 P185/60R-13	165/65R-14 P175/60R-14	135R-15	
1520	165R-13 P165/80R-13 P175/70R-13 P195/60R-13	165/70R-14 P175/65R-14	145R-15	
1525	175-13 P175/75R-13 P175/80R-13 P185/70R-13 P195/70R-13 P205/60R-13	165R-14 P165/75R-14 P175/70R-14 P175/75R-14 P185/60R-14 P185/65R-14 P195/60R-14 195/65R-14 205/65R-14	155R-15 185/55R-15 P195/50R-15 195/55R-15	
1530	185R-13 P185/80R-13 P205/70R-13	P175R-14 P185/70R-14 P185/75R-14 P205/60R-14 P215/60R-14	165R-15 P165/80R-15 P175/70R-15 P185/60R-15 P185/65R-15 P195/60R-15 P205/50R-15 P205/55R-15	195/50R-16
1535		P195/70R-14	175R-15 P185/70R-15 P190/65R-390 P195/65R-15	P205/50R-17
1540		195R-14 P205/70R-14 P215/70R-14 P215/65R-14 P255/60R-14 P225/60R-14 P255/70R-14	185R-15 P195/70R-15 205/65R-15 P215/60R-15 P205/60R-15	P205/55R-16
1545		205R-14 215R-14 P215/75R-14 P225/70R-14 P235/60R-14	P195/75R-15 P205/70R-15 P215/60R-15 P225/60R-15	P215/60R-16 P235/50R-16 P215/55R-16
1547		P225/75R-14 P245/60R-14	P265/50R-15	P205R-16 P225/55R-16 P225/55R-17
1550			205R-15 P205/75R-15 P215/70R-15 P235/60R-15	P215/65R-16 P225/60R-16 225/55R-16 215/70R-16
1553			P225/70R-15 P255/60R-15 P245/60R-15	235/60R-16 P245/55R-16
1555			P235/65R-15 P235/70R-15 P275/50R-15	P225/70R-16 P255/50R-16





# A15 PL / PLE series



■ "PL" & "PLE" series are specially designed for passenger cars. PL & PLE series passenger car chains excel in their outstanding traction, especially for PLE series snow chains.

■ They adopt "D" design 4.5 mm square link, gaining better traction.

■ They can be for use on original equipment with highway type tread.



## Tire Size Table of PL / PLE Car Chains

Item No.	Tire Sizes		
PL1110 PLE1110	145R12; 155R12; 135R13; P165/70R12; P145/80R12; P155/65R13; P145/70R13; P135/80R13		
PL1114 PLE1114	6.00-12; 145R12; 155R12; P175/70R12; P155/80R12; P165/60R13; P165/65R13; P175/60R13; P185/65R13; P155/70R13; P165/70R13; P165/75R13; P145/80R13; 145R13; 155R13; P155/80R13	135R14; 145R14; P165/60R14; P155/65R14; P145/70R14;	135R15
PL1118 PLE1118	165R13; P185/60R13; P165/70R13; P175/70R13; P175/75R13; P165/80R13;	155R14; P175/60R14; P185/60R14; P165/65R14; P185/55R14; P175/65R14; P155/70R14; P165/70R14; P165/75R14; P165/80R14;	P165/65R15; P145/70R15; P155/70R15; P145/80R15; P165/70R360; 145R15; P165/70R365;
PL1122 PLE1122	P175/80R13	175R14; P195/55R14; P175/75R14; P185/75R14; P175/80R14;	5.60-15; 155R15; 165R15; 185/55R15; P195/55R15; P185/60R15; P195/60R15; P185/65R15; P165/70R15; P175/70R15; P175/75R15; P165/80R15; P155/80R15;
PL1126 PLE1126	175R13; 185R13; P195/60R13; P205/60R13; P215/60R13; P195/65R13; P185/70R13; P195/70R13; P185/75R13; P195/75R13; P175/80R13; P185/80R13	P205/55R14; P195/60R14; P195/65R14; P175/70R14; P185/70R14; P185/65R365;	P220/45R15; P195/50R15; P205/50R15; P185/60R15; P185/65R15; P175/70R15; P185/65R390;
PL1130 PLE1130	195R13; P215/65R13; P205/70R13; P185/85R13;	7.00-14LT; 185R14; 6.00-14LT; P215/60R14; P225/60R14; P205/65R14; P215/65R14; P195/70R14; P195/75R14; P185/80R14;	175R15; P225/50R15; P190/65R15; P190/65R390; P195/65R15; P205/65R15; P185/70R15; P185/70R365; P195/70R15; P185/75R15; P205/60R15; P200/60R390
PL1134 PLE1134	P235/50R13; P245/50R13; P235/60R13	195R14; 205R14; P225/65R14; P225/60R14; P205/70R14; P215/70R14; P205/75R14; P215/75R14	185R15; 195R15; P215/60R15; P225/60R15; P205/65R15; P205/70R15; P195/75R15; P205/75R15; P195/80R15; P205/50R16; P205/55R16; P215/55R16; P205/60ZR16; P215/60ZR16
PL1138 PLE1138		205R14; 215R14; P265/50R14; P255/55R14; P245/60R14; P255/60R14; P225/70R14; P235/70R14; P225/75R14	7.75-15; 205R15; 215R15; P245/50R15; P215/60R15; P235/60R15; P165/65R15; P225/65R15; P215/70R15; P225/70R15; P205/75R15; P225/55R16; P235/55R15; P215/75R15; P245/50ZR16; P235/45R17; P220/65R390; P225/60ZR16; P205/65R16; P215/60ZR16
PL1142 PLE1142		225R14; P265/60R14; P275/60R14; P245/70R14;	8.55-15; 215R15; 225R15; 230R15; 235R15; P265/50R15; P275/50R15; P245/60R15; P255/60R15; P265/60R15; P275/60R15; P255/65R15; P235/70R15; P245/70R15; P225/75R15; P235/75R15; P225/80R15; P235/60R16; P245/60R16;

# A16 12 / 18 series



- 12 / 18 series passenger car chains are designed for vehicles requiring SAE class "U" tire chains.
- Vehicles with regular non-restricted wheel well clearances.
- Do not use these chains on vehicles designated as SAE class "S" limited clearance.
- V bar design makes it especially good for ice road drive. (18 car chains only.)



## Tire Size Table of 12 / 18 Car Chains

Item No.	Tire Sizes		
1206 1806	6.00-12; 165/70-12; 145-12; 155-12; 175/70-12; 155/80-12; 145-13; 155-13; 145/80-12; 175/60-13; 165/70-13; 135-13; 165/65-13; 145/80-13; 155/70-13	135-14; 165/65-14	135-15
1210 1810	215/50-13; 165-13; 185/60-13; 175/70-13; 175-13	6.00-14; 175/65-14; 175-14	5.60-15; 165-15; 175/70-15
1217 1817	155/80-13; 165/75-13; 185-13	195/55-14; 155-14; 175/60-14; 165/70-14; 165/75-14; 165/80-14; 175/75-14; 165-14; 175/70-14	155-15; 185/55-15; 145-15; 165/65-15; 155/80-15
1230 1830	195/60-13; 165/80-13; 205/60-13; 175/80-13; 235/50-13; 245/50-13; 185/70-13; 195/70-13; 185/75-13; 185/80-13	185/65-14; 205/60-14; 195/60-14; 195/65-14; 205/55-14; 185/70-14; 185/60-14; 185-14; 225/55-14	220/45-15; 195/50-15; 205/50-15; 185/60-15; 185/65-15; 195/55-15; 215/50-15; 185/75-15; 175-15; 225/50-15; 195/60-15; 195/65-15; 205/55-15; 205/55ZR16; 205/75-15
1240 1840		7.00-14; 215/60-14; 205/65-14; 185/75-14; 205/75-14; 185/80-14; 195/75-14; 215/65-14; 195-14; 205/70-14	185/70-15; 185-15; 195-15; 205/60-15; 215/60-15; 195/70-15; 195/75-15; 225/50-16
1250 1850		235/60-14; 235/70-14; 225/75-14; 225-14	205/70-15; 215-15; 215/70-15; 225/70-15; 215/75-15; 225-15; 230-15; 235/70-15; 8.55-15; 7.00-15
1254 1854		205-14; 215-14; 225/70-14; 215/70-14; 225/65-14; 215/75-14; 225/60-14	7.75-15; 205-15; 205/65-15; 215/65-15; 215/60-16; 225/55-16; 225/60-16; 205/65-16; 215/65-16; 215/70-16

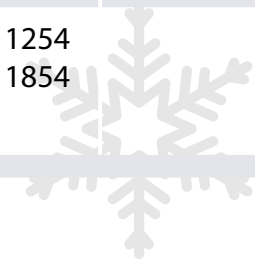





# B

## Jeep Chains

**B1** KNR Series P.28-29

**B2** 23 / 25 Series P.30-31

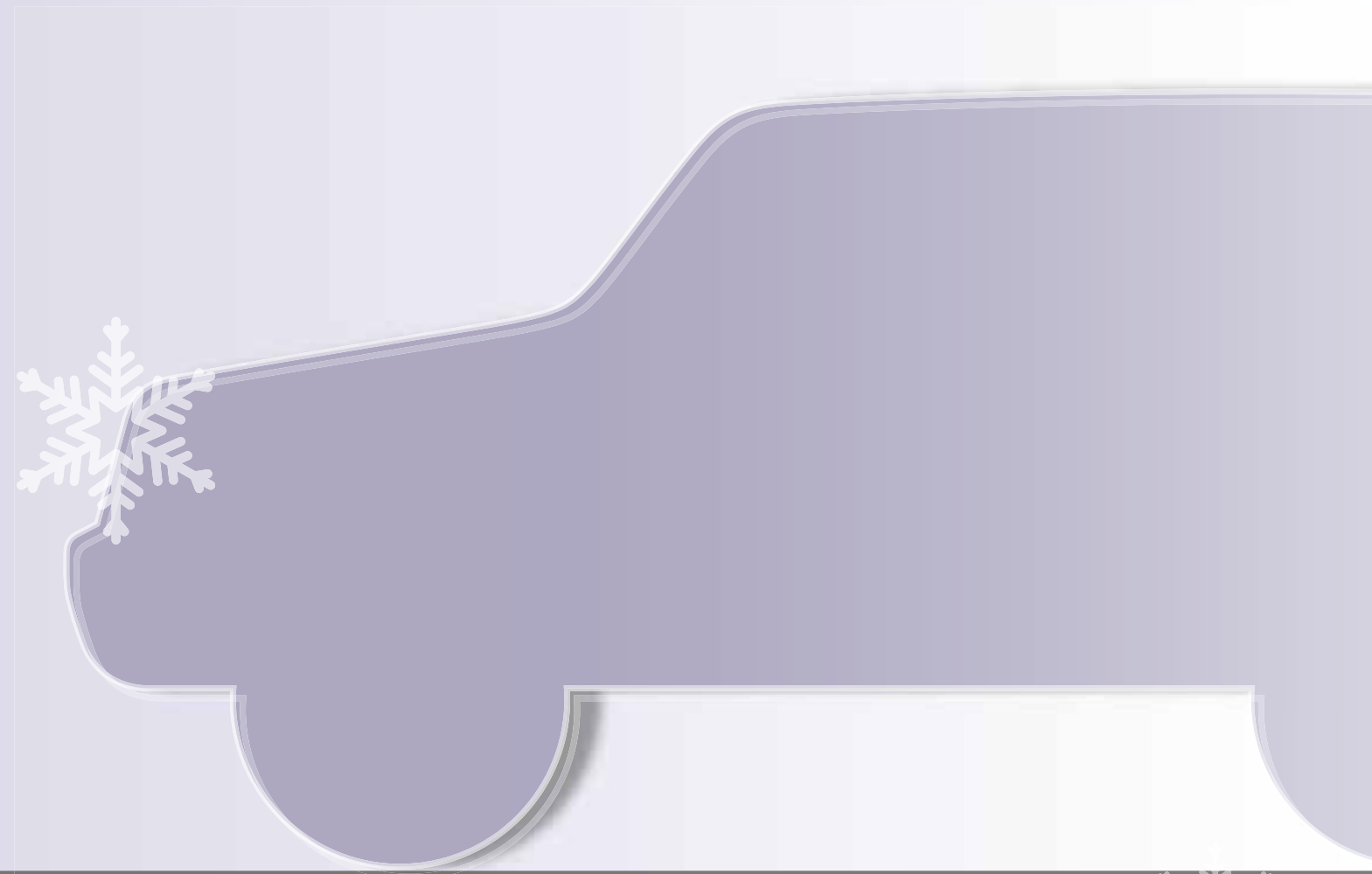

# BI KNR series



- Diamond tire chains pattern insures a comfortable drive with less vibration and noise.
- Maximum traction with minimal brake distance and skidding.
- The small square links and the short length of each cross chain minimizes wear and breakage.
- Easily operated chain tensioning system
- Fitted in minutes, without the need to jack up, or move the car.
- 4.5 mm "D" type strong square link, suitable for 4X4 jeeps and vans.
- Flexible steel cable covered with plastic sheath.
- Thermal treated electro-galvanised chains
- Elegant and strong plastic case or bag, safe and convenient, spacesaving.
- Comes complete with installation instructions, repair links 1 pair / case



## KNR Jeep Chains Mounting Steps



## Tire Size Table of KNR Jeep Chains

Item	Tire Sizes									
190	165-14	165/75-14	185/65-14							
200	175-14	650-14	175/75-14	175/80-14	185/70-14					
205	6.70-13									
210	185-14 175/80-15	700-14	185/75-14	195/70-14	205/65-14	215/65-14	185/80-14	640-15	165-15	
220	195-14 175/75-16	670-14 175/80-16	195/75-14 195/65-16	205/70-14	215/70-14	185-15	195/70-15	205/65-15	175-16	
225	205-14 185/75-16	205/75-14 205/65-16	245/60-14	195-15	195/75-15	205/75-15	205/70-15	215/65-15	195/80-15	
230	215-14 600-16	750-14 640-16	215/75-14 195/75-16	670-15 215/70-16	215/70-15 215/65-16	225/70-15 205/70-16	205/80-15 8.00-16.5	G.R.78x15 215/75-15	185-16 195-16	
240	215-15 205/80-16	700-15 205/75-16	225/75-15 235/60-16	255/60-15 7-17.5	235/70-15 700-16	H.R78x15 205/65-17.5	215/80-15 225/65-16	205-16	650-16	
245	28x9-15 225/60-17	235/75-15	235/70-15	215-16	215/75-16	225/75-16	225/70-16	215/80-16	650-17	
246	27/8.50-15									
247	30x9.50-15	8.40-15	235/70-16	215/85-16	255/70-15	235/65-17				
250	9-15 700-16	750-15 245/65-17	265/70-15 235/80-16	245/70-16 245/75-16	255/65-16	8-17.5	205/75-17.5	215/75-17.5	750-16	
255	10-15 255/50-19	255/75-15 255/60-17	265/75-15	31x10.50-15	255/70-16	275/55-17	285/50-18	255/55-18	255/60-18	
260	235/85-16	8.5-17.5	225/75-17.5	7-19.5						
265	31x11.50-15	265/75-16	265/70-16	280/70-16	265/65-17	285/45-19				
268	31x11.50-15									
270	825-15 245/70-17.5	825-16	9.5-17.5	235/75-17.5	700-18	750-18	8-19.5	650-20	700-20	
275	265/70-19.5									
280	825-17	10-17.5	9-19.5	9.5-19.5	750-20	800-20	8-22.5	225/90-20		
290	11.00-16	825-20	9-22.5	8.3-24	255/70-22.5					
295	305/70-19.5	295/60-22.5	285/60-22.5							
296	12-16.5	33x12.50-15	11.5/80-15.3	285/75-16						
300	900-20	10-22.5	C22.5 Pilote	11/70-22.5	9.5-24	275/70-22.5	295/70-22.5	305/60-22.5		
310	1000-20	D20 Pilote	11-22.5	D22.5 Pilote	12/80-20	275/80-22.5	305/70-22.5	315/70-22.5	12.4-20	
320	1100-20	E22.5 Pilote	315/80-22.5	315/75-22.5	305/75-24.5	315/75-24.5				
330	1200-20	1100-22	13-22.5	1000-24						
350	275/70-19.5	285/70-19.5	900-16	255/100-16	315/70-15					
360	12.5-18	12.5/80-18	335/80-18	365/70-18	320/70-20					
370	13.6-16 295/80-22.5	12.4-20 13/75-22.5	E20	11.2-24	13/80-20	12.5-20	12-22.5	12/80-22.5	335/80-20	
380	1300-20Pilote	14.75/80-20	365/80-20							
390	1400-20									



# B2 23 / 25 series



ALLOY STEEL



- Diamond tire chains pattern in-sures a comfortable drive with less vibration and noise.
- Maximum traction with minimal brake distance and skidding.
- Fitted in minutes, without the need to jack up, or move the car.
- 3.8mm (23 series) 4.5mm (25 series) "D" type strong squre link, suitable for 4X4 jeeps and vans



## Tire Size Table of 23/25 Series

Stock No.	Tire Sizes		
	15" Rims	16/16.5" Rims	17" and other Rims
2318	7.00R15 235/75R15LT P245/70R15	P225/75R16 8.75R16.5	
2317		P245/70R16 9.50R16.5 215/85R16LT	8R17.5 255/60R17
2319	30/9.50R15 P255/70R15 P275/60R15	225/75R16LT P255/65R16 P235/70R16 255/65R16	
2321	P265/75R15 P255/75R15	235/85R16LT	P265/60R18
2324	245/85R15LT P265/70R15 31/10.50R15 31/11.50R15	P255/70R16 7.50R16 245/75R16LT 255/70R16LT P265/70R16 265/70R16 275/70R16	275/60R17
2326	32/11.50R15 33/9.50R15	265/75R16LT 255/85R16LT P265/75R16	225/70R19.5 8R19.5 265/70R17LT P255/75R17 P265/70R17 285/60R17
2516	215/75R15LT	8.00R16.5	
2517	30/9.50R15 P255/70R15 P275/60R15	215/85R16LT 215/80R16LT 32/10.00R16 9.50R16.5 P255/65R16 255/65R16	8R17.5 215/75R17.5
2518	31/9.50R15	235/70R16LT P245/70R16	
2519	235/75R15LT 7.50R15 7.00R15 P235/75R15	P225/75R16	
2521	P265/75R15 P255/75R15	235/85R16LT 275/70R16	
2524	31/10.50R15 NR78-15 P265/70R15  33/9.50R15 32/11.50R15	245/75R16LT P245/75R16 7.50R16 P255/70R16 255/70R16LT P265/70R16 265/70R16	
2526		265/75R16LT P265/75R16 255/85R16LT	225/70R19.5 8R19.5 P255/75R17 P265/70R17 265/70R17LT
2532		33/12.50R16.5	285/60R18
2533		285/75R16LT 305/70R16	





## Garden & ATV Chains

- C1** Garden Series P.34
- C2** ATV Series P.35
- C3** Forklift Series P.36





# C1 Garden series



Designed for plow & garden tractors, or all terrain vehicles.

### Tire Size Table of Garden Chains

Item No.	Tire Sizes			
3301 --	10/10.5X2.75	10.25X3.25	10X3.50	
3308 --	12X3			
7106 --	4.10/3.50X4	3.40/3.00X5		
3302 --	4.10/3.50X5	4.10/3.50X6	12/3.50X6	12.25/3.50X6
3309 --	5.30/4.50X6			
7129 --	13X5X6			
1301 --	4.00/4.80X8			
3303 --	5.00/5.70X8			
3300 --	16X6.50X8	15X6.00X6		
3312 --	18X6.50X8			
3307 3311	18X8.50X8			
3305 3306	18X9.50X8			
7145 5320	20X10X8			
1308 5318	20X8.00X10	20X8X8		
7121 7109	20X10X10			
5313 5312	6X12	23X7.50X12		
4300 4301	8X12	23X8.50X12		
5308 5306	12X12	26X12X12	27X12X12	

2 Link Spacing	Tire Sizes
Stock Number	
1302G	4.00X4.80-8
3310G	4.10X3.50-6
7156G	13X5-6
3315G	16X6.50X8

# C2 ATV series



### Tire Size Table of ATV Series

Item No.	Tire Sizes
ATV-100	20X11X8
ATV-101	22X11X8
ATV-102	25X12X9
ATV-103	25X13X9
ATV-104	26X12X12

4-Link Spacing	2-Link Spacing	Tire Sizes
Part Number	Part Number	
110	111	"22x8.00-10 23x7.00-10 22x9.00-8 22x10.00-9 23x8.00-11 23x8.00-10 23x10.00-10 22x10.00-8 22x10.00-10"
310	311	"23x10.50x12 24x11x8 24x11.0-9 24x11.0-10 24x13.00-9 25x11.00-9 25x12.00-9 25x12.00-10"
510	511	"22x11.00-8 22x11.00-9 22x11.00-10 24-9.00-11 24x10.00-11 25x10.00-12"
610	611	25x8.00-12 24x9.00x12
	711	26x12-10 26x12-12

4-Link Spacing	2-Link Spacing	Tire Sizes
Stock Number	Stock Number	
810	610	22X8X11 20X11X8
811	611	23X8X11 24X8X11 26X8X12
812	612	25X8X11 25X8X10
815	615	22X11X8 22X12X8 22X11X10 22X10X10 23X10X10
818	618	24X9X11 25X10X12 24X11X10 24X11X9 25X8X12
820	620	"25X13X9 25X13.9X9 25X12X9 25X12X10 24X12X10 24X13X9 24X13X12"

# C3 Forklift series



■ Square link cross chains

■ TWO-link spacing available upon request"

### Tire Size Table of Forklift Chains

Stock Number	Tire Sizes
2108FL	6.50-10
2110FL	7.50-10 25x8.50-14
2116FL	7.00-12 27x8.50-15 28x9.50-15 7.00-15 28x9-15 29x8-15 8.15-15
2121FL	7.50-15
2125FL	23x10.50-12
2129FL	250-15 27x10.50-15
2128FL	8.25-15
3135FL	14-17.5







# D

## Truck Chains

**D1** TN Series P.40-41

**D2** TND Series P.42-43

**D3** 3S Series P.44-45

**D4** 20 / 40 Series P.46-47

**D5** 22 / 42 Series P.48-49

**D6** 28 / 48 V Bar Series P.50-51

**D7** 32 Wide Base Series P.52-53

**D8** 24 / 44 Series P.54-55

**D9** Emergency Series P.55



# D | TN series



- High traction on snow and ice thanks to its "D" shape chains.
- Good road handling and comfortable ride.
- Tightening with tensioning chain and lever.
- Anti-wear heat treatment.
- Zinc galvanizing.
- Packaged in cotton bag.



1 PAIR PER BAG  
PACKED ON PALLETS

## Tire Size Table of TN Truck Chains

Item No.	Tire Sizes	Item No.	Tire Sizes
190	165-14 165/75-14 185/65-14	273	250/80-16
200	175-14 650-14 175/75-14 175/80-14 185/70-14	274	245/70-19.5 250/80-18 265/70-19.5
205	6.70-13	275	265/70-19.5
210	185-14 700-14 640-15 185/75-14 195/70-14	277	10.5-18 10.5/80-18 275/80-18 9.5-20
220	195-14 670-14 185-15 175-16 17-380 195/75-14 175/75-16 195/70-15 205/65-15 195/65-16 175/80-16 205/70-14 215/70-14	280	825-17 10-17.5 9-19.5 9.5-19.5 750-20 800-20 8-22.5 225/90-20
225	205-14 195-15 205/75-14 205/75-15 185/75-16 205/70-15 195/75-15 215/65-15 205/65-16	285	300X15 315/70-15
230	215-14 750-14 670-15 GR78-15 185-16 195-16 640-16 8.00-16.5 215/75-14 195/75-16 215/70-16 225/70-15 600-16 215/75-15 225/70-15 215/65-16 205/85-16	290	11.00-16 825-20 9-22.5 8.3-24 255/70-22.5
240	215-15 700-15 HR78-15 205-16 650-16 7-17.5 225/75-15 205/75-16 205/65-17.5 205/80-16 225/65-16 255/60-15 235/60-16 235/70-15 215/80-15 700-16	295	305/70-19.5 295/60-22.5 285/60-22.5
245	28X9-15 215-16 235/75-15 235/70-15 215/85-16 215/75-16 225/75-16 215/80-16 225/70-16 650-17 225/60-17	296	12-16.5 33X12.50-15 11.5/80-15.3 285/75-16
246	27X8.50-15	300	900-20 10-22.5 C22.5 Pilote 11/70-22.5 9.5-24 275/70-22.5 295/70-22.5 305/60-22.5
247	30X9.50-15 8.40-15 215-380 255/70-15 235/70-16 235/65-17	305	315/60-22.5
248	250-15 250/70-15	310	1000-20 D20 Pilote 11-22.5 D22.5 pilote 12/80-20 275/80-22.5 305/70-22.5 315/70-22.5 12.4-20
250	9-15 750-15 700-16 8-17.5 245/70-16 205/75-17.5 215/75-17.5 265/70-15 245/65-17 255/65-16 235/80-16 245/75-16 750-16	320	1100-20 E22.5 Pilote 315/80-22.5 315/75-22.5 305/75-24.5 315/75-24.5
255	10-15 255/75-15 265/75-15 31X10.50-15 31X10.50-16.5 255/70-16 255/60-17 275/55-17 285/50-18 255/55-18 255/60-18 255/50-19	330	1200-20 1100-22 13-22.5 1000-24
258	10-16.5 10.0/80-12 10.0/75-15.3	350	275/70-19.5 285/70-19.5 900-16 255/100-16 315/70-15
260	8.5-17.5 7-19.5 235/85-16 225/75-17.5	358	11.2-20 10.5-20 275/80-20 300/70-20
263	29X12.50-15	360	12.5-18 12.5/80-18 335/80-18 365/70-18 320/70-20
264	29X13.50-15	370	13.6-16 12.4-20 12.5-20 E20 Pilote 11.2-24 13/80-20 12/80-22.5 335/80-20 295/80-22.5 13/75-22.5
265	31X11.50-15 265/75-16 280/70-16 265/70-16 265/65-17 285/45-19	380	1300-20 Pilote 14.75/80-20 365/80-20
267	31X15.50-15 275/70-16 265/70-17	390	1400-20
268	31X15.50-15	400	1200-24 F24 Pilote 14/80-24
270	825-15 825-16 9.5-17.5 235/75-17.5 700-18 750-18 8-19.5 650-20 700-20 245/70-17.5	520	14.5-20 F20 Pilote 15-22.5 14/80-20 365/80-20 375/75-20 385/65-22.5 320/70-24 14.9-20 15.22-5
		525	16.5-22.5 425/65-22.5
		530	18-22.5 445/65-22.5





# D2 TND series



- High traction on snow and ice thanks to its "D" shape chains and cross links reinforced.
- Good road handling and comfortable ride.
- Tightening with tensioning chain and lever.
- Anti-wear heat treatment.
- Zinc galvanizing.
- Packaged in cotton bag.



## Tire Size Table of TND Truck Chains

Item No.	Tire Sizes	Item No.	Tire Sizes
190	165-14 165/75-14 185/65-14	273	250/80-16
200	175-14 650-14 175/75-14 175/80-14 185/70-14	274	245/70-19.5 250/80-18 265/70-19.5
205	6.70-13	275	265/70-19.5
210	185-14 700-14 640-15 185/75-14 195/70-14	277	10.5-18 10.5/80-18 275/80-18 9.5-20
220	195-14 670-14 185-15 175-16 17-380 195/75-14 175/75-16 195/70-15 205/65-15 195/65-16 175/80-16 205/70-14 215/70-14	280	825-17 10-17.5 9-19.5 9.5-19.5 750-20 800-20 8-22.5 225/90-20
225	205-14 195-15 205/75-14 205/75-15 185/75-16 205/70-15 195/75-15 215/65-15 205/65-16	285	300X15 315/70-15
230	215-14 750-14 670-15 GR78-15 185-16 195-16 640-16 8.00-16.5 215/75-14 195/75-16 215/70-16 225/70-15 600-16 215/75-15 225/70-15 215/65-16 205/85-16	290	11.00-16 825-20 9-22.5 8.3-24 255/70-22.5
240	215-15 700-15 HR78-15 205-16 650-16 7-17.5 225/75-15 205/75-16 205/65-17.5 205/80-16 225/65-16 255/60-15 235/60-16 235/70-15 215/80-15 700-16	295	305/70-19.5 295/60-22.5 285/60-22.5
245	28X9-15 215-16 235/75-15 235/70-15 215/85-16 215/75-16 225/75-16 215/80-16 225/70-16 650-17 225/60-17	296	12-16.5 33X12.50-15 11.5/80-15.3 285/75-16
246	27X8.50-15	300	900-20 10-22.5 C22.5 Pilote 11/70-22.5 9.5-24 275/70-22.5 295/70-22.5 305/60-22.5
247	30X9.50-15 8.40-15 215-380 255/70-15 235/70-16 235/65-17	305	315/60-22.5
248	250-15 250/70-15	310	1000-20 D20 Pilote 11-22.5 D22.5 pilote 12/80-20 275/80-22.5 305/70-22.5 315/70-22.5 12.4-20
250	9-15 750-15 700-16 8-17.5 245/70-16 205/75-17.5 215/75-17.5 265/70-15 245/65-17 255/65-16 235/80-16 245/75-16 750-16	320	1100-20 E22.5 Pilote 315/80-22.5 315/75-22.5 305/75-24.5 315/75-24.5
255	10-15 255/75-15 265/75-15 31X10.50-15 31X10.50-16.5 255/70-16 255/60-17 275/55-17 285/50-18 255/55-18 255/60-18 255/50-19	330	1200-20 1100-22 13-22.5 1000-24
258	10-16.5 10.0/80-12 10.0/75-15.3	350	275/70-19.5 285/70-19.5 900-16 255/100-16 315/70-15
260	8.5-17.5 7-19.5 235/85-16 225/75-17.5	358	11.2-20 10.5-20 275/80-20 300/70-20
263	29X12.50-15	360	12.5-18 12.5/80-18 335/80-18 365/70-18 320/70-20
264	29X13.50-15	370	13.6-16 12.4-20 12.5-20 E20 Pilote 11.2-24 13/80-20 12/80-22.5 335/80-20 295/80-22.5 13/75-22.5
265	31X11.50-15 265/75-16 280/70-16 265/70-16 265/65-17 285/45-19	380	1300-20 Pilote 14.75/80-20 365/80-20
267	31X15.50-15 275/70-16 265/70-17	390	1400-20
268	31X15.50-15	400	1200-24 F24 Pilote 14/80-24
270	825-15 825-16 9.5-17.5 235/75-17.5 700-18 750-18 8-19.5 650-20 700-20 245/70-17.5	520	14.5-20 F20 Pilote 15-22.5 14/80-20 365/80-20 375/75-20 385/65-22.5 320/70-24 14.9-20 15.22-5
		525	16.5-22.5 425/65-22.5
		530	18-22.5 445/65-22.5



# D3 3S series



- Uniquely designed with its "CAM" fastening systems.
- Specially designed cross chains to gain excellent traction.
- Anti-wear design thanks to its extra rings mounted on cross chains.
- Tightening becomes easier with the help of cams.
- Additional chain parts are provided in order to be suitable for as many tire sizes as possible.
- Chains can be made longer easily with the additional chain in case of need.

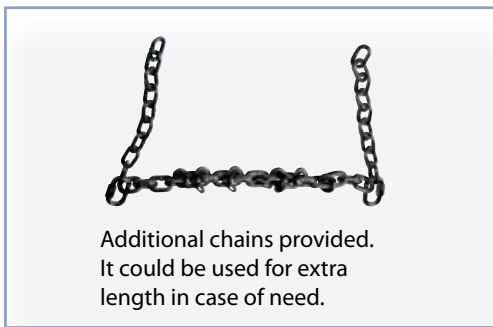

Tire Size Table of 3S Truck Chains

Item No.	Tire Sizes		
1	6.70-13 7.25-13	165-14; 175-14 185-14; 195-14 205-14; 215-14 650-14; 670-14 700-14	215-15; 195/70-15 195/75-15; 205/65-15 205/75-15; 215/70-15 175-16; 185-16 195-16; 205-16 600-16
2			750-15; 10R15; 10.5-15; HR78-15; 215-16; 700-16; 750-16; 650-17; 750-17; 225/75-17; 9-15; 10-15; 10.5-15; 10/75-15; 825-15; 10.5-16; 900-16; 825-17; 8-17.5; 8.5-17.5; 9.5-17.5; 10-17.5; 215/75-17.5; 225/75-17.5; 235/75-17.5; 700-18; 750-18; 7-19.5; 8-19.5; 9-19.5; 600-20; 650-20; 700-20; 750-20; 800-20; 825-20; 825-20; 9.5-20; 8-22.5; 9-22.5; 225/70-22.5
3			10.5-18; 12.5-18; 900-20; 5-20; 10-20; 10.5-20; 11-20; 12-20; 12/80-20; 12.5-20; 13/80-20; 14/80-20; 14.5-20; 14.75/80-20; 225/90-20; D20 Pilote; D20; E20; E20 Pilote; F20 Dunlop; F20 Pilote; 11-22; 10-22.5; 11-22.5; 12-22.5; 12/70-22.5; 12/80-22.5; 13-22.5; 13/70-22.5; 15-22.5; 275/70-22.5; 275/80-22.5; 295/70-22.5; 295/80-22.5; 305/75-22.5; 315/70-22.5; 315/75-22.5; 315/80-22.5; C22.5 Pilote; D22.5 Pilote; E22.5 Pilote; 9.5-24; 11.2-24; 10-24; 305/75-24.5; 315/75-24.5
4			205/70-19.5; 275/70-19.5; 285/70-19.5;

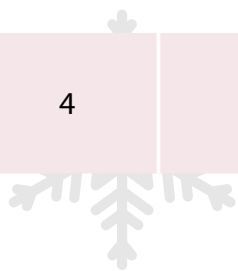



# D4 20 / 40 series



- The light weight construction makes handling and installation easier.
- They can be used for modern vehicles with very limited clearance. They have little throw off and therefore need less space.
- Any cross members that wear out can be replaced using only pliers and screw drivers.
- They are designed for todays truck. The carbon steel spring gives excellent traction on ice.



## Tire Size Table of 20 / 40 Truck Chains

Item No.	Tire Sizes
2014/4014	7.50-17; 7.00-18; 8-19.5; 225/70R17.5
2016/4016	9-14.5MH; 6.50-16LT; 8.00-16.5; 215/75R15LT; P225/75R15; P235/75R15; H78-15LT; 205R16
2019/4019	7.00-15TR; 7.00-16LT; 8.75-16.5LT; 8-17.5; 235/75R15LT; 245/70R15LT; 215/80R16LT; 215/85R16LT; 225/75R16LT; 245/70R16LT; 215/70R17.5
2021/4021	P265/75R15; 7.50-16LT; 9.50-16.5LT; 7.00-17LT; 275/60R15LT; 235/85R16LT; 245/75R16LT; 215/75R17.5LT; LR78-16LT; NR78-15
2028/4028	8.25-15TR 255/85R16LT 265/75R16LT
2029/4029	10-16.5LT; P245/70R15; P255/70R15; 255/75R15LT; 30X9.50-15LT; 235/70R16LT; 32X9X16; 32X10X16
2033/4033	7.50-18; 6.5-20; 7.00-20; 225/70R19.5
2037/4037	9.00-15TR; 9.00-16LT; 9R17.5; 10R17.5; 7.50-20; 8-22.5
2039/4039	10.00-15TR; 8.25-20; 9-22.5; 11R17.5; 245/75R22.5; 255/70R22.5; 255/80R22.5
2041/4041	9.00-20; 10-22.5; 265/70R19.5; 265/75R22.5; 275/80R22.5; 295/75R22.5
2045/4045	10.00-20; 11-22.5; 275/70R22.5; 275/80R24.5; 285/75R24.5
2049/4049	10.00-22; 11-24.5; 12.5-22.5

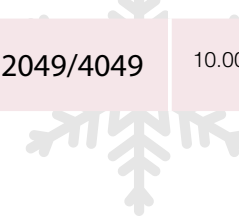

# D5 22 / 42 series



■ 22, 42 series single/dual truck chains are designed specially for truck, with their compact design, they stand out in their strong traction character.

■ As to these with "CAM" accessories, tightening becomes much easier.

## Tire Size Table of 22 / 42 Truck Chains

Item No.	Tire Sizes
2006/4206	8-14.5MH; 6.00-16LT
2209/4209	7.00-14LT; 185-14; P195/75R14; P205/75R14; 195/75R14LT; 205/60R17.5; E78-14ST; 28X8.50X14
2211/4211	6.70-15LT; 7.00-15LT; 7-17.5LT; P215/75R15; 27X8.50-14LT; H70-14ST; H78-14ST; H78-15ST; LR78-15
2214/4214	7.50-17; 7.00-18; 8-19.5; 225/70R17.5
2216/4216	9-14.5MH; 6.50-16LT; 8.00-16.5; 215/75R14LT; 215/75R15LT; P225/75R15; P235/75R15; 205R16; H78-15LT
2219/4219	7.00-15TR; 7.50-15LT; 7.00-16LT; 8.75-16.5; 8.50-17.5; 235/75R15LT; 245/70R15LT; 215/80R16; 215/85R16LT; 225/75R16LT; 235/75R16LT; 215/70R17.5LT; 245/70R16LT; 245/75R15LT
2221/4221	7.50-15TR; 7.50-16LT; 9.50-16.5; 7.00-17LT; P265/75R15; 275/60R15LT; 235/85R16LT; 245/75R16LT; 215/75R17.5LT; L78-16LT; NR78-15
2228/4228	8.25-15TR; 255/85R16LT; 265/75R16
2229/4229	10-16.5LT; P245/70R15; P255/70R15LT; 30X9.50-15LT; 30/9.50-16; 32X9X16; 32X10X16; 235/70R16LT
2231/4231	8.25-15TR; 255/85R16LT; 265/75R16
2233/4233	7.50-18; 6.5-20; 7.00-20; 225/70R19.5; 245/70R19.5
2237/4237	9.00-15TR; 9.00-16LT; 9R17.5; 10R17.5; 7.50-20; 8-22.5
2239/4239	10.00-15TR; 8.25-20; 9-22.5; 11R17.5; 245/75R22.5; 255/70R22.5; 255/80R22.5; QR78-16
2241/4241	9.00-20; 10-22.5; 265/70R19.5; 265/75R22.5
2245/4245	10.00-20; 11-22.5; 275/70R22.5; 275/80R22.5
2247/4247	295/75R22.5; 275/80R24.5; 285/75R24.5
2249/4249	10.00-22; 11-24.5;
2251/4251	11.00-15TR; 11.00-20; 12-22.5; 295/80R22.5;
2253/4253	11.00-24
2255/4255	12.00-20; 13/80R20; 11.00-22; 12.5-22.5; 12.75-22.5; 12-24.5; 315/80R22.5
2257/4257	13.00-20; 14/80R20; 12.00-24; 365/80R20



# D6 24 / 48 V Bar series



28  
SINGLE TRUCK CHAINS



48  
DUAL TRUCK CHAINS



V-BAR REINFORCED

- 28 / 48 single / dual truck chain is designed specially for truck or bus.
- With its "V" bar across the cross chain, it achieves better traction, especially when drive on ice road.

## Tire Size Table of 28 / 48 "V" Bar Truck Chains

Item No.	Tire Sizes
2806/4806	8-14.5MH; 6.00-16LT
2809/4809	7.00-14LT; 185-14; P195/75R14; P205/75R14; 195/75R14LT; 205/60R17.5; E78-14ST; 28X8.50X14
2811/4811	6.70-15LT; 7.00-15LT; 7-17.5LT; P215/75R15; 27X8.50-14LT; H70-14ST; H78-14ST; H78-15ST; LR78-15
2814/4814	7.50-17; 7.00-18; 8-19.5; 225/70R17.5
2816/4816	9-14.5MH; 6.50-16LT; 8.00-16.5; 215/75R14LT; P225/75R15; P235/75R15; 205R16; H78-15LT
2819/4819	7.00-15TR; 7.50-15LT; 7.00-16LT; 8.75-16.5; 8.50-17.5; 235/75R15LT; 245/70R15LT; 215/80R16; 215/85R16LT; 225/75R16LT; 235/75R16LT; 215/70R17.5LT; 245/70R16LT; 245/75R15LT
2821/4821	7.50-15TR; 7.50-16LT; 9.50-16.5; 7.00-17LT; P265/75R15; 275/60R15LT; 235/85R16LT; 245/75R16LT; 215/75R17.5LT; L78-16LT; NR78-15
2828/4828	8.25-15TR; 255/85R16LT; 265/75R16
2829/4829	10-16.5LT; P245/70R15; P255/70R15LT; 30X9.50-15LT; 30/9.50-16; 32X9X16; 32X10X16; 235/70R16LT
2831/4831	8.25-15TR; 255/85R16LT; 265/75R16
2833/4833	7.50-18; 6.5-20; 7.00-20; 225/70R19.5; 245/70R19.5
2837/4837	9.00-15TR; 9.00-16LT; 9R17.5; 10R17.5; 7.50-20; 8-22.5
2839/4839	10.00-15TR; 8.25-20; 9-22.5; 11R17.5; 245/75R22.5; 255/70R22.5; 255/80R22.5; QR78-16
2841/4841	9.00-20; 10-22.5; 265/70R19.5; 265/75R22.5
2845/4845	10.00-20; 11-22.5; 275/70R22.5; 275/80R22.5
2847/4847	295/75R22.5; 275/80R24.5; 285/75R24.5
2849/4849	10.00-22; 11-24.5;
2851/4851	11.00-15TR; 11.00-20; 12-22.5; 295/80R22.5;
2853/4853	11.00-24
2855/4855	12.00-20; 13/80R20; 11.00-22; 12.5-22.5; 12.75-22.5; 12-24.5; 315/80R22.5
2857/4857	13.00-20; 14/80R20; 12.00-24; 365/80R20

# D7 32 Wide Base series



■ Specially designed for dual & wide base truck & bus.

■ They can be divided into single / dual two kinds.



## Tire Size Table of 32 Wide Base Truck Chains

Item No.	Tire Sizes	
3210	10-15LT 10-16.5LT 30-9.50-15LT 29X9.50-16	
3227	11-15LT 10-17.5LT 31X10.5R-15LT 31X11.5-15LT 31X10.5-16.5LT 31X11.5-16.5LT 32X9.50-15LT 32X11.5-15LT 33X9.50R15 34X9.50-15LT 11-50-15	
3228	275/70R16	
3229	12-15LT 12-16.5LT 31X12.5-15LT 32X11.5-15LT 32X12.5-15LT 33X12.5-15LT 33X12.5-16.5LT 32-12.50-16.5LT 255/85R16 245/70R19.5	
3235	14-17.5LT 35X12.5X15 35X14X15LT 36X12.50X15LT 37X12.50X15LT 38X15X15LT 36.5X14X16 35X12.5X16.5 35X14X16.5 36X14X16.5 38.5X16X16.5 38X15.5R16.5	
3237	31X15.5-15LT 35X15X15 35X15.5X15	7.00-15TR 6.50-16LT 7-17.5LT
3249	35X14.50X15LT 38X15.5X15 38.5X16X15 38.5X16X16.5	8-17.5LT
3251	35X15-15LT 36X14X15LT 36X14.50X15LT 39.5X15X16.5 40X17X15	7.50-15LT 7.50-15TR 7.50-16LT 7.00-17 235/85R16
3255	16.5-19.5 15-22.5 385/65R22.5 365/80R20 365/70R22.5	
3257	18-19.5	
3259	38X12.5-15LT 38X14.5-15LT	7.00-18 8-19.5 6.50-20 7-22.5
3261	19.5-19.5 18-22.5 445/65R22.5	
3265	38X15X16LT 15-19.5	7.50-17 7.00-20
3267	42X15-15LT	
3269	44X18.5X15 44X18.5X16.5	
3271	16.5-22.5 425/65R22.5	
3273	9.00-20 10-22.5	
3275	10.00-20 11-22.5	
3277	11.00-20 10.00-22 9.00-24 11.00-24.5	

Item No.	Tire Sizes	
3210CAM	10-15LT 10-16.5LT M-50-15	
3227CAM	11-15LT 10-17.5LT 31X10.50-15LT 31X11.50-15LT 32X11.50-15LT 31X10.50-16.5LT 31X11.50-16.5LT 31X15.5-15LT 32X9.50X15LT	
3229CAM	12-15LT 12-16.5LT 14.35-15 12-16.5 31X12.50-15LT 33X12.5-15LT 33X12.50-16.5LT 32X12.50-15LT	
3255CAM	16.5-19.5 15-22.5 385/65R22.5 365/80R20 365/70R22.5	





# D8 24 / 44 series



- Extra heavy duty construction for off-road use
- Now constructed with longerwearing high-strength steel



## Tire Size Table of 24 / 44 Chains

Item No.	Tire Sizes
2433*	6.50-16LT
2435	7.00-15TR; 7.50-15LT; 7.50-15TR; 9R15LT; 7.00-16LT; 8.75-16.5; 8-17.5; 235/75R15LT; 215/85R16LT; 225/75R16LT; 235/75R16LT; 245/70R16LT; 9.00-15TR
2437	7.50-16LT; 7.00-17LT; 9.50-16.5; 215/75R17.5; 235/85R16LT; 255/65R15LT; 275/60R15LT; P245/70R15; P275/60R15; P255/70R15; 30X9.50-15LT; LR78-16LT; N78-15
2439	225/70R19.5; 7.50-17; 8-19.5; 245/75R16LT; 245/70R19.5
2441	7.50-25; 10-15LT; 10.00-15TR; 8.25-20; 9-22.5; 245/75R22.5; 255/70R22.5
2445	9.00-20; 10-22.5; 265/75R22.5; 275/80R22.5
2448	10.00-20; 11-22.5; 275/70R22.5
2452	11.00-20; 10.00-22; 12-22.5; 11-24.5; 295/75R22.5; 275/80R24.5; 285/75R24.5
2486	12.00-20; 13/80R20; 11.00-22; 315/80R22.5
2470	11.00-24; 295/80R22.5
4412	7.50-16LT; 7.50R16LT; 7.00-17LT; 9.50-16.5; 215/75R17.5; 235/85R16LT; 255/65R15LT; 275/60R15LT; P245/70R15; P275/60R15; P255/70R15; 30X9.50-15LT; LR78-16LT; N78-15
4435	7.50-25; 10-15LT; 10.00-15TR; 8.25-20; 9-22.5; 245/75R22.5; 255/70R22.5
4437	9.00-20; 10-22.5; 265/75R22.5; 275/80R22.5
4448	10.00-20; 11-22.5
4461	11.00-20; 10.00-22; 12-22.5; 11-24.5; 295/75R22.5; 275/80R24.5; 285/75R24.5
4486	12.00-20; 13/80R20; 11.00-22; 12.5-22.5; 12-24.5; 315/80R22.5

# D9 Emergency series

## Tire Size Table of Emergency Chains

Item No.	Tire Sizes				
XS	185-16	185/75-16	195-16	195/75-16	205-16
	205/75-16	215-16	215/75-16	600-16	215/85-16
	640-16	225/75-16	650-16	7-17.5	19-400
S	700-16	750-16	825-16	8-17.5	8.5-17.5
	9.5-17.5	205/75-17.5	215/75-17.5	225/75-17.5	235/75-17.5
	700-18	7-19.5	8-19.5	650-20	
M	825-17	9-19.5	9.5-19.5	245/70-19.5	265/70-19.5
	275/70-19.5	285/70-19.5	9.5-20	750-20	825-20
	8-22.5	9-22.5	225/70-22.5		
L	305/70-19.5	900/20	10-22.5	275/70-22.5	295/70-22.5
	295/60-22.5	305/60-22.5	9.5-24		
XL	1000-20	1100-20	1200-20	12.5-20	12/80-20
	13/80-20	1100-22	11-22.5	12-22.5	12/80-22.5
	13-22.5	275/80-22.5	295/80-22.5	305/70-22.5	315/60-22.5
	315/70-22.5	315/75-22.5	315/80-22.5	11.2-24	305/75-24.5
	315/75-24.5				





# E

## Tractor & Forest Chains

**E1** 26 / 29 Series P.58

**E2** Tractor Series P.59

**E3** Double Ring Series P.60

**E4** 08 Series P.61



**E5** Big Ring & Diamond Studded Series P.62-63





# E1 26 / 29 series

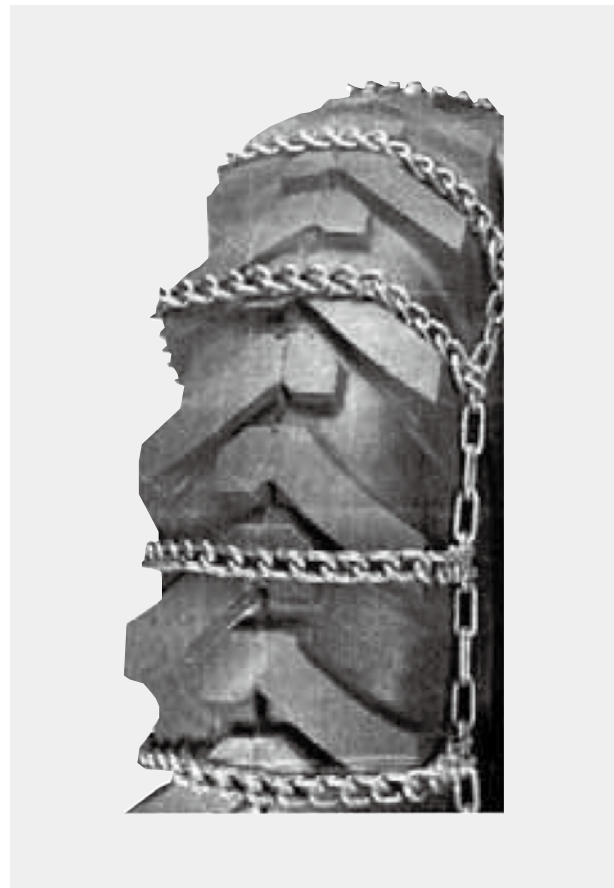

- Two link spacing available upon request.
- Now constructed with longerwearing high-strength steel.



### Tire Size Table of 26/29 Series

Item No.	Tire Sizes
2612	13.00-24/25; 14.00-21/21; 15.5-25
2615	14.00-24; 14.00-25
2624	16.00-20/21; 17.5-25
2627	16.00-24; 16.00-25
2633	20.5-25
2636	18.00-25; 18.00-24; 18.00-26
2642	18.00-33
2645	23.5-25
2657	26.5-25; 755/70R25

Item No.	Tire Sizes
2912	13.00-24/25; 14.00-20/21; 15.5-25
2915	14.00-24; 14.00-25
2917	16.00-24; 16.00-25

# E2 Tractor series

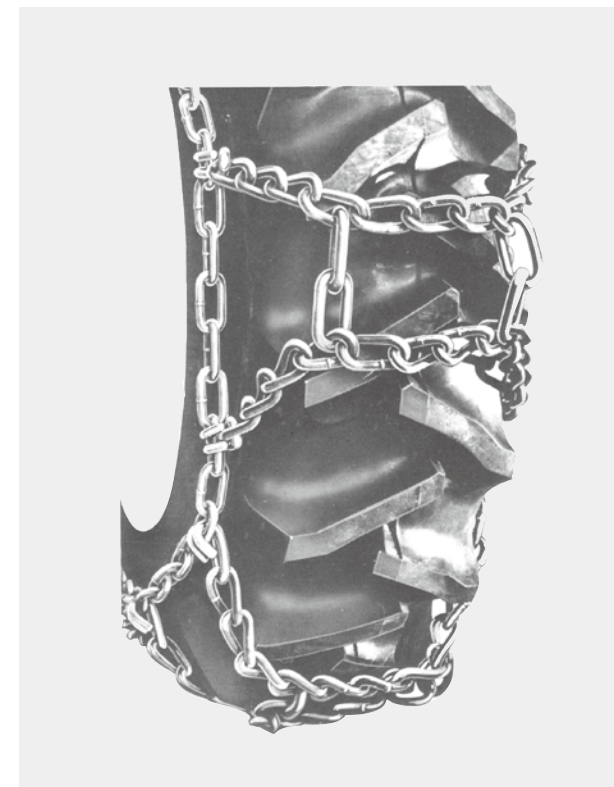

- Especially adapted for tractor tires with deep treads.
- The cross chains ride high and do not drop into the grooves of the tractor tire.

### Tire Size Table of Tractor Chains

Item No.	Tire Sizes
214	9.5-28 11.2-24
218	11.2-32 12.4-28 10-32 11-28
224	11.2-34 11.2-36
226	9.5-32 11.2-28
227	9.5R44
228	8.3R44 9.5R40
229	12.4-24
232	11.2-38 12.4-36 12.4-38
236	9.5R48 11.2-44
240	13.6-24 13.6-26
242	13.6-28 14.9-24
246	12.4-42 13.6-36 13.6-38 12-36
248	12.4R46
250	14.9-26 14.9-28
252	14.9-30
254	14.9-38
256	14.9-46
259	12.4R52
261	12.4-54
262	16.9-26 16.9-28
264	18.4-16.1
266	16.9-30 16.9-32
268	18.4-24 19.5L-24
269	18.4-28
270	16.9-34 15.5-38
271	18.4-30
272	16.9-38
273	18.4-34
274	18.4-38
275	21L-24
276	20.8-38
277	18.4-46
278	24.5-32
280	23.1-26
281	23.1-30
282	23.1-34

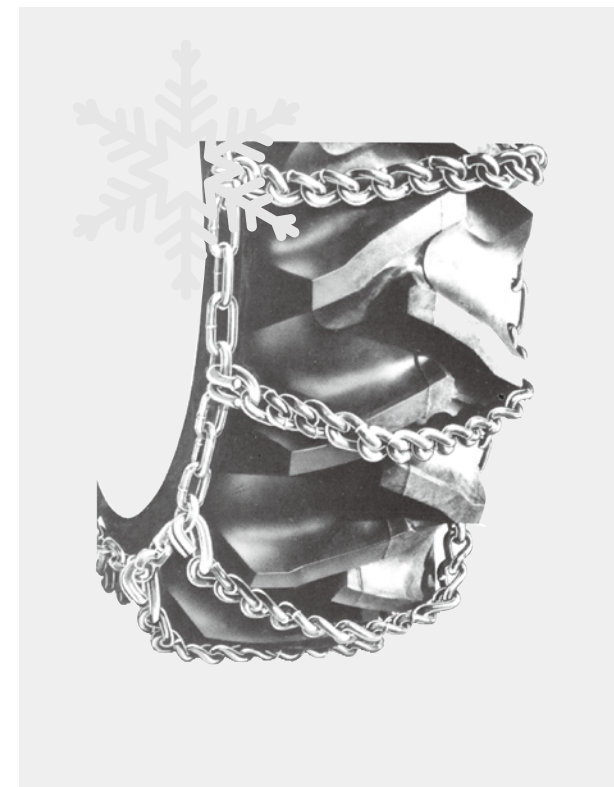

# E3 Double Ring series

Tire Size Table of Double Ring Series

Item No.	Tire Sizes
722	8.3-24; 9.5-18
729	9.5-16
732	9.5-24; 10.5x80x18
734	12.5x80x18 Front Backhoe
736	11.2-24; 9.5-28; 12.4x16
738	11.2-28; 9.5-32; 13.5-16.1
746	11.2-34; 11.2-36
750	13.6-16
752	12.4-24; 15-22.5
756	12.4-28; 13.6-24
758	13.6-24; 13.6-26; 41x14-20
772	13.6-28; 14.9-24
762	11.2-38; 12.4-36; 12.4-38
766	13.6-38; 13.6-36; 13.9-36
769	14.9-26; 14.9-28
771	14.9-38
774	16.9-24; 17.5L-24
776	16.9-26; 16.9-28; 14.9-30
777	16.9-30; 16.9-32
779	16.9-34; 15.5-38
780	16.9-38
781	18.4-16.1**
782	21.5-16; 21.5L-16.1
783	18.4-24; 19.5L-24; 18.4-26
784	18.4-28
785	18.4-30; 21L-24
787	18.4-34
789	18.4-38
790	20.8-34
791	23.1-26
792	20.8-38
793	23.1-30
794	18.4-42
795	23.1-34



- 2 1 / 2 Inch Double Welded Rings
- Self Clfaning
- Best Ice & Mud Traction



# E4 08 series

Tire Size Table of 08 Series

Item No.	Tire Sizes
0829	9.5-16; 10.00-16.5
0822	8.3-24; 10.50/80-18; 12.50/80-18; 315/75D15; 12-16.5
0823	9.5-24; 7.2-24
0836	11.2-24; 9.5-28; 355/80-20; 15-19.5
0852	12.4-24; 41x14.00-20
0838	11.2-28; 9.5-32
0856	12.4-28
0846*	11.2-34; 11.2-36; 270/95R36; 290/95R34; 11.2-32
0862	11.2-38; 12.4-36; 12.4-38; 9.5-36; 9.5-38
0850	13.6-16; 14-17.5
0858	13.6-24; 13.6-26
0859	13.6-28; 14.9-24
0869	14.9-26; 14.9-28
0866	13.6-38; 12.4-42; 13.6-36; 12.4-40
0874	16.9-24; 17.5L-24; 17.5-24
0876	16.9-26; 16.9-28; 14.9-30
0877	16.9-30
0879	16.9-34; 15.5-38
0883	18.4-26; 19.5L-24; 18.4-24
0884*	18.4-28
0885	18.4-30; 21L-24
0887	18.4-34
0889	18.4-38
0894*	18.4-42; 14.9-46; 420/80R-46

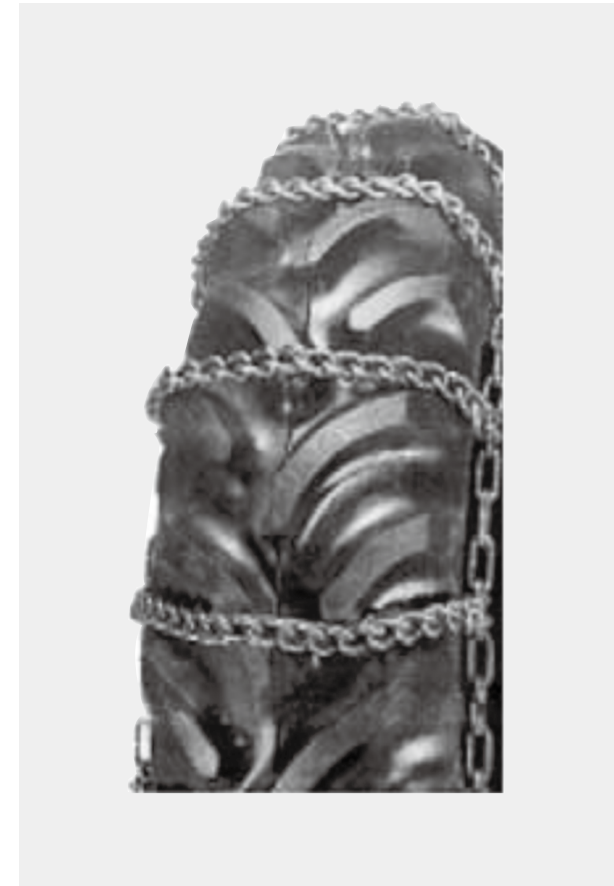

- Now constructed with longer-wearing high-strength steel
- Available to the extent of existing inventories





# E5 Big Ring & Diamond Studded

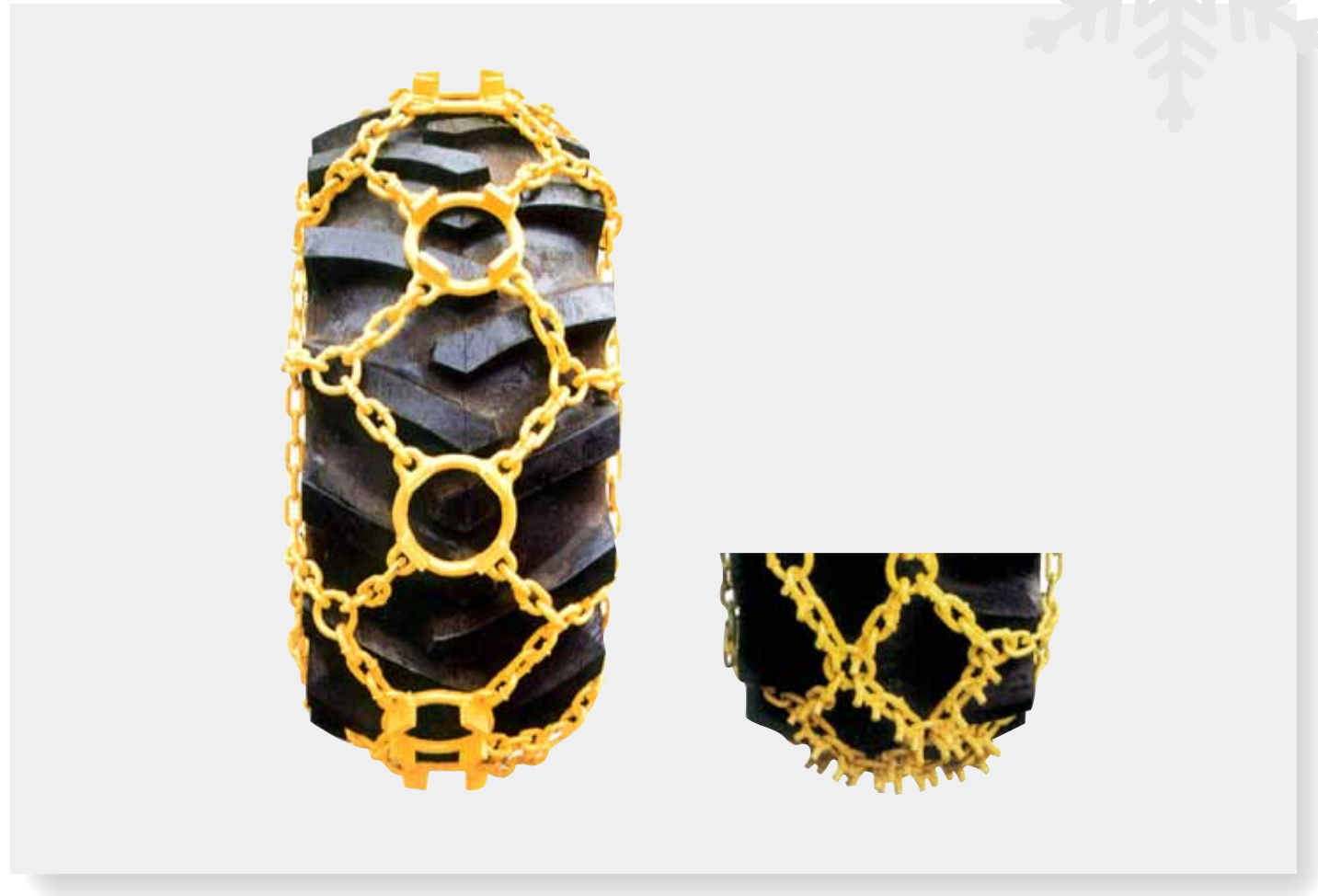

- Hardened carbon steel
- Incredible traction.
- Oversized wear links.



Tire Size Table of Big Ring Skidder Chains & Diamond Studded Skidder Chains

Item No.	Tire Sizes
19010-9/16"	18.4X34 23.1X26
19020-5/8"	16.9X30 18.4X26
19030-5/8"	18.4X34 23.1X26
19060-5/8"	30.5X32
19045-5/8"	28LX26
19050-5/8"	24.5X32





# F

## Accessories





TLC-1



**Twist Link Cross Chains**

Stock No.	Material Diameter		Application
	Inches	mm	
1/0	3/16	4.5	Passenger Car
3/0	13/64	5.25	Passenger / Jeep
4/0	15/64	5.94	Light Truck
6/0	9/32	7.14	Truck
7/0	5/16	7.93	Heavy Truck
9/0 TRUCK	3/8	9.52	Truck / Equipment
9/0 TRACTOR	3/8	9.52	Tractor
11/0	7/16	11.1	Truck / Equipment
14/0	17/32	13.48	Truck / Equipment

SLC-1



**Square Link Cross Chain**

Stock No.	Material Diameter		Application
	Inches	mm	
101	3/32	2.5	Passenger Car
102	9/64	3.5	Passenger Car
103	5/32	3.8	Passenger Car
104	11/64	4.5	Passenger / Jeep
105	3/16	5.6	Light Truck
107	1/4	7.0	Truck
108	5/16	8.2	Truck / Equipment
110	3/8	10.0	Heavy Equipment
112	7/16	12.0	Heavy Equipment

RLC-1



**Side Chain**

Stock No.	Material Diameter		Application
	Inches	mm	
#1	5/32	4.1	Passenger
1/0	11/64	4.5	Passenger
2/0	3/16	4.88	Passenger / Jeep
4/0	7/32	5.54	Light Truck
6/0	9/32	7.14	Truck
7/0 TRUCK	5/16	7.93	Truck / Equipment
7/0 TRACTOR	5/16	7.93	Tractor
9/0	3/8	9.52	Heavy Equipment
11/0	7/16	11.1	Heavy Equipment
13/0	1/2	12.7	Heavy Equipment

**Side Chain**

Stock No.	Material Diameter		Application
	Inches	mm	
201	3/32	2.5	Passenger
202	3/64	3.0	Passenger
203	9/64	3.5	Passenger
204	5/32	4.0	Passenger / Jeep

CCH-1

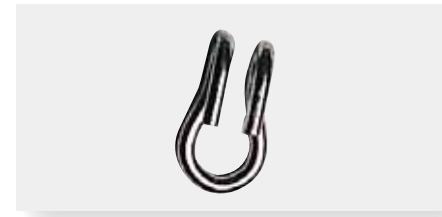

CCH-2

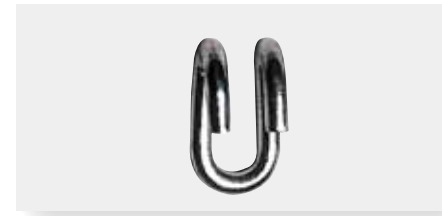

CCH-3



SCR-1



CCR-1



CCR-2



**Cross Chain Hooks**

Stock No.	Material Diameter		Application
	Inches	mm	
401	3/32	2.5	Passenger Car
402	9/64	3.5	Passenger Car
403	5/32	4.0	Passenger Car
404	11/64	4.5	Passenger / Jeep
405	3/16	5.0	Passenger / Jeep
406	1/4	6.35	Light Truck
407	5/16	7.93	Truck
409	3/8	9.52	Heavy Truck
410	13/32	10.3	Small Equipment
411	7/16	11.1	Heavy Equipment
413	13/32	13.48	Heavy Equipment

**Side Chain Repair Links**

Stock No.	Diameter	Application
303	3/64 x 1	Passenger
305	3/16 x 1-1/8	Passenger / Jeep
306	1/4 x 1-1/4	Light Truck
308	5/16 x 1-1/2	Heavy Truck
309	3/8 x 1-5/8	Tractor
312	1/2 x 2-1/2	Tractor

**Cross Chain Repair Links**

Stock No.	Material Diameter		Application
	Inches	mm	
505	13/64	5.25	Passenger
506	1/4	6.35	Light Truck
507	9/32	7.1	Truck
508	5/16	7.93	Heavy Truck

**Cross Chain Repair Links (Square Link)**

Stock No.	Material Diameter		Application
	Inches	mm	
601	3/32	2.5	Passenger Car
602	9/64	3.5	Passenger Car
603	5/32	3.8	Passenger Car
604	11/64	4.5	Passenger / Jeep
605	3/16	5.6	Light Truck
607	1/4	7.0	Truck
608	5/16	8.2	Truck / Equipment
610	3/8	10.0	Heavy Equipment

**EQL-1**



**Emergency Quick Links**

Stock No.	Material Diameter		Application
	Inches	mm	
703	7/64	3.5	Passenger Car
704	3/16	4.76	Light Truck
706	1/4	6.35	Truck
708	5/16	7.93	Heavy Truck
709	3/8	9.52	Heavy Equipment
711	7/16	11.1	Heavy Equipment
712	1/2	12.7	Heavy Equipment

**SCR-2**



**Side Chain - Speed Hooks**

Stock No.	Material Diameter		Application
	Inches	mm	
805	3/16	5.0	Passenger
806	1/4	6.35	Passenger / Jeep
808	5/16	7.93	Light Truck
809	3/8	9.52	Truck
811	7/16	11.1	Heavy Truck

**Semicircle**

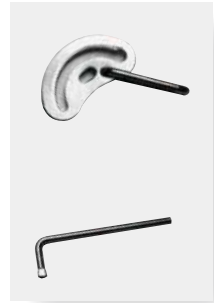

**Circle**

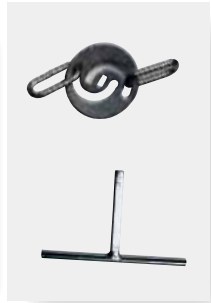

**Dual Semicircle**

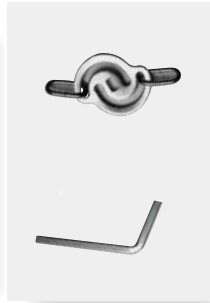

**Cam Tighteners and Tool**

Stock No.	Type	Application
901	Semicircle	Light Truck
902	Semicircle	Truck
903	Semicircle	Heavy Truck
904	Circle	Light Truck
905	Circle	Truck
906	Circle	Heavy Truck
907	Dual Semicircle	Light Truck
908	Dual Semicircle	Truck
909	Dual Semicircle	Heavy Truck

**Outside - Side Chain Fasteners**

Stock No.	Application
1000	Passenger Car
1001	Passenger Car
1002	Passenger Car
1003	Passenger Car
1004	Light Truck
1005	Heavy Truck
1006	Heavy Truck
1007	Heavy Equipment
1008	Passenger
1009	Light Truck
1010	Heavy Truck
1011	Light Truck
1012	Light Truck
1013	Light Truck
1014	Heavy Truck



**Forge Hook**

Stock No.	Application
1305	Light Truck
1306	Heavy Truck
1307	Heavy Truck

**1101-1103**



**1104-1105**

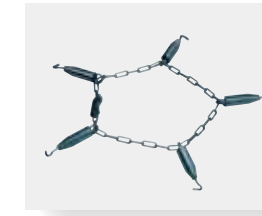

**Chain Type**

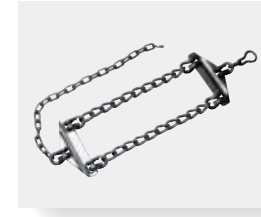

**Belt Type**



**Tire Chain Adjusters**

Stock No.	Type	Application
1101	Rubber	Passenger Car
1102	Rubber	Light Truck
1103	Rubber	Heavy Truck
1104	Chain	Light Truck
1105	Chain	Heavy Truck

**Emergency Chains**

Stock No.	Type	Application
1200	Belt Type	Passenger Car
1201	Belt Type	Light Truck
1202	Belt Type	Heavy Truck
1203	Chain Type	Heavy Truck

**Belt Type**



**Chain Repair Pliers**

Stock No. P-1





Flat Hooks



Rubber Hook

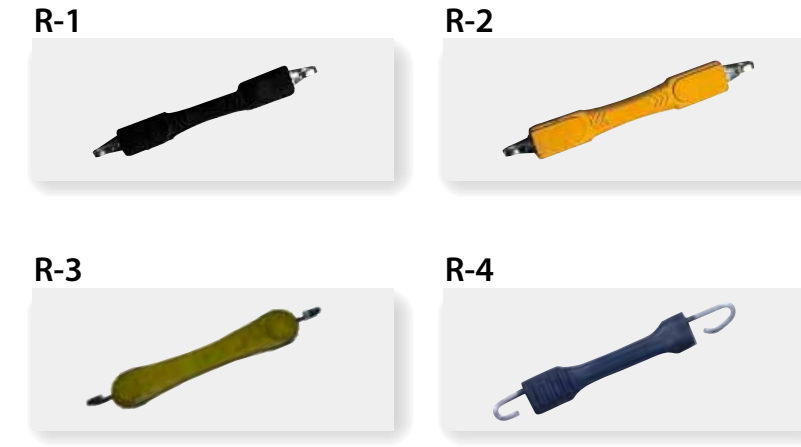

Lock System



Spring Hook



Shortening Hooks For Tension Chains



Quick Dismount System

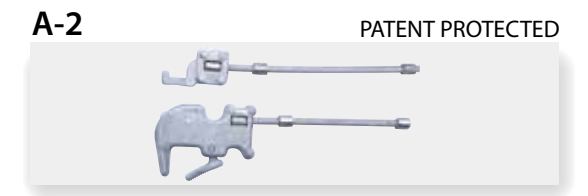

Metal Tag



Rubber Tensioner



Cable Connection Nipples

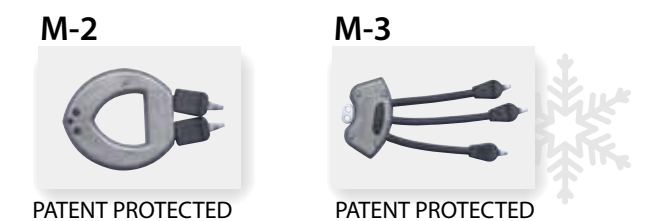



# G

Tech Guide





**Definition of SAE classification:**

**SAE class "U"** - Regular (non-reinforced) and lug reinforced passenger tire chains for vehicles with regular (non-restricted) wheel well clearances.

**SAE class "S"** - Regular (non-reinforced) passenger tire chains and cables for vehicles with restricted wheel well clearances.

**SAE class "W"** - Those passenger tire chains that use light truck components, as well as some light truck chains.

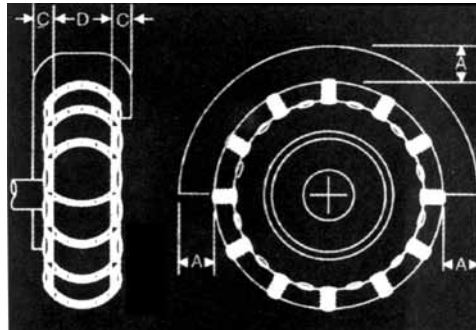

**Note:** For design purposes "D" is the maximum grown tire section width as established by the tire and rim association (tra). The minimum clearances specified must be maintained around spring clamp, spring bolts, fenders, braces, splash pans, fuel lines, brake lines, brake controls, and wherever necessary.

**MINIMUM CLEARANCES REQUIRED FOR TIRE CHAINS.**

Tire Chain Identification	Three Envelope (A)	Minimum Dimensions (C)
SAE Class "S"	1.46" (37mm)	0.59" (15mm)
SAE Class "U"	1.97"(50mm)	0.91" (23mm)
SAE Class "W"	2.50"(63.5mm)	1.50"(38.1mm)

**KNOW YOUR EXACT TIRE SIZE**

This is the series of numbers and letters printed on the side of every tire. On most modern tires, the tire size will look like this: P205/70-14. This example indicates that the tire is 205mm wide, has an aspect ratio of 70% and is mounted on a wheel whose diameter is 14 inches. All of these numbers are critical in helping you to find the traction products that will fit your tire.

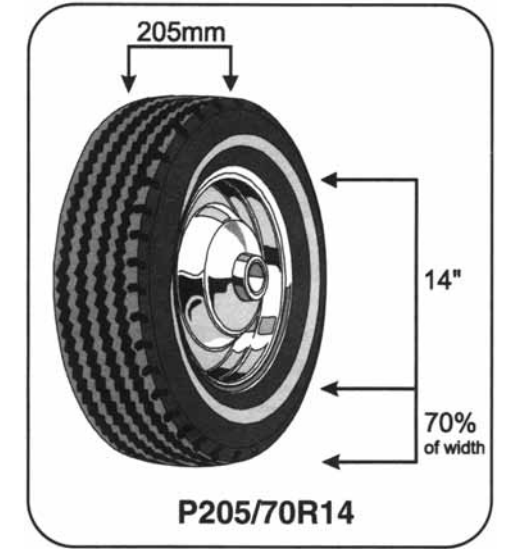

**SPECIAL NOTE:** It is always necessary to pre-fit your chains to your tire and vehicle before you actually need to use them. Individual tire manufacturers use different molds for the same numerical tire size. This can cause a variance in the dimensions of as much as 7% from one brand to another.

**WHICH TIRES TO CHAIN UP**

The vehicle's drive tires are the tires on which snow chains should be installed. On vehicles with front-wheel drive this would be the two front tires and on vehicles with rear wheel drive this would be the rear tires. If you're not sure which type of drive system you have, check the vehicle owner's manual. Also, if you have a four-wheel drive or all-wheel drive vehicle and only intend to chain up two tires, always check the owner's manual for advice on which axle to chain up. To alleviate confusion and retain as much of the normal handling characteristics of your 4WD/ AWD as possible, install traction devices on all four tires.

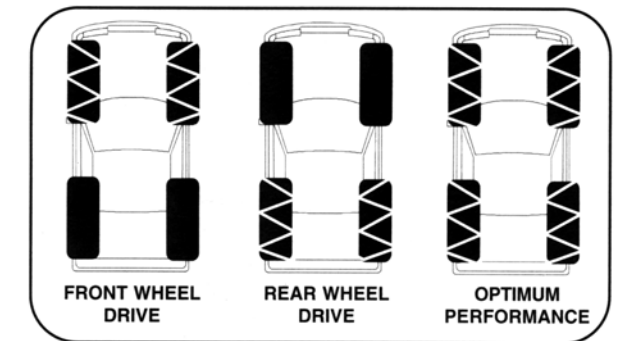

Under normal driving conditions, a vehicle has about the same amount of traction at each wheel, creating a feeling of "normal" control during braking, acceleration and cornering. Under snow and ice conditions this balance is destroyed. If snow chains are installed only on the front tires, the rear of the vehicle can swing during braking and driving. If snow chains are only installed on the rear tires, the steering ability of the vehicle is limited. To get this balance back, the vehicle should be completely equipped with snow chains. Remember that traction devices are sold in pairs. Therefore, if you want to cover both axles (all four tires) on the vehicle, you must purchase two pairs.

**FOR CARS ANTI-LOCK BRAKES (ABS)**

Many people think that ABS systems are an alternative to traction devices. Not true. ABS is a great advantage in helping drivers maintain vehicle control, but it's only purpose is to "manage" the vehicle's available traction more efficiently than a conventional braking system. When snow chains are mounted correctly, stopping traction for the ABS system to manage is actually increased.

## FOR FOUR-WHEEL DRIVE VEHICLES

Four-wheel drive vehicles definitely need to use snow chains to maintain control. Although four-wheel drive or all-wheel drive vehicles have a greater ability to go than vehicles with a conventional drive system, they do not have a greater ability to stop under winter driving conditions.

## EMERGENCY CHAINS

Emergency chains are designed for emergency use only! Emergency chains are not designed for any continuous driving. Another restriction of use is that these types of products can only be used with slotted wheels. In addition, we always recommend the use of at least one pair per drive tire, mounted opposite of each other. The purpose of these devices is only to get the vehicle UN-stuck from a parking lot, driveway, side street, etc. Emergency chains should be removed before continuous driving.

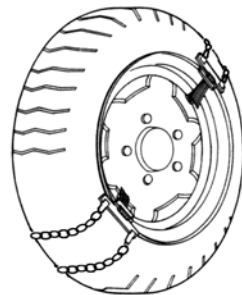

## DIFFERENCE BETWEEN TRACTION ON SNOW AND ICE

With some vehicles, it is possible, to slow down and get by when driving on fresh snow, even without the aid of a winter traction device. However, packed snow or ice is a different situation. Under those conditions all vehicles are either parked, safely equipped with a traction device or out of control.

## WINTER WEATHER DRIVING TIPS

- Before beginning your trip, know the current road conditions and the weather forecast for the areas that you will be traveling.
- Be prepared for changing conditions during your trip. Keep an emergency winter driving kit in your car consisting of blankets, water, high energy snacks, highway warning devices, a flashlight and fresh batteries.
- Be aware of potentially dangerous icy areas such as shady spots and bridges and overpasses. Slow down in these areas as ice is sometimes invisible.
- Always keep your car's windows, mirrors and lights clear of snow and ice.
- Keep a safe distance behind other vehicles, especially plows and sanding trucks. Remember that stopping distances are doubled or tripled on snow or ice. Never pass a snowplow or sanding truck as they throw gravel that could damage your vehicle.
- Do not leave your vehicle parked along the roadside where it could hit by other vehicles or snowplows who can not see it when snow accumulates and covers your vehicle from view. This is more likely with a lighter colored vehicle.

# RULES & ATTENTION

## Rules for using tire chains:

**Important:** Profit chains prior to actual use! For your convenience and safety:

1. Consult owner's manual to see if chain can be used on your vehicle.
2. Make certain your tire chains are properly sized for your tires. A proper fit is key to performance.
3. Follow directions for installing tire chains. Apply as tightly as possible by hand for maximum chain life.
4. Be sure to pull off highway to safe place before installing, servicing or removing tire chains.
5. Do not deflate tires to install tire chains.
6. Drive approximately 1/4 mile. Stop & retighten. Extra links may be cut off or preferably retained on the fastener arm.
7. Do not drive at high speed. Accelerate or decelerate slowly. Avoid spinning or locking of wheels.
8. If a cross chain should fail, stop immediately. Repair. Do not drive with a broken chain.
9. Avoid hitting curbs with tire chain.
10. Tire chains are not designed for towing vehicles.

Tire size must be known in order to select a tire chain of correct fit. For passenger cars, vans and small pick-up trucks it is important to check the owner's manual. The restricted wheel well clearances in most of today's down-sized and front drive vehicles may require the use of SAE class "S" tire chains, as noted in the manuals.

## THE COMPARISON BETWEEN CORRECT & INCORRECT USAGE

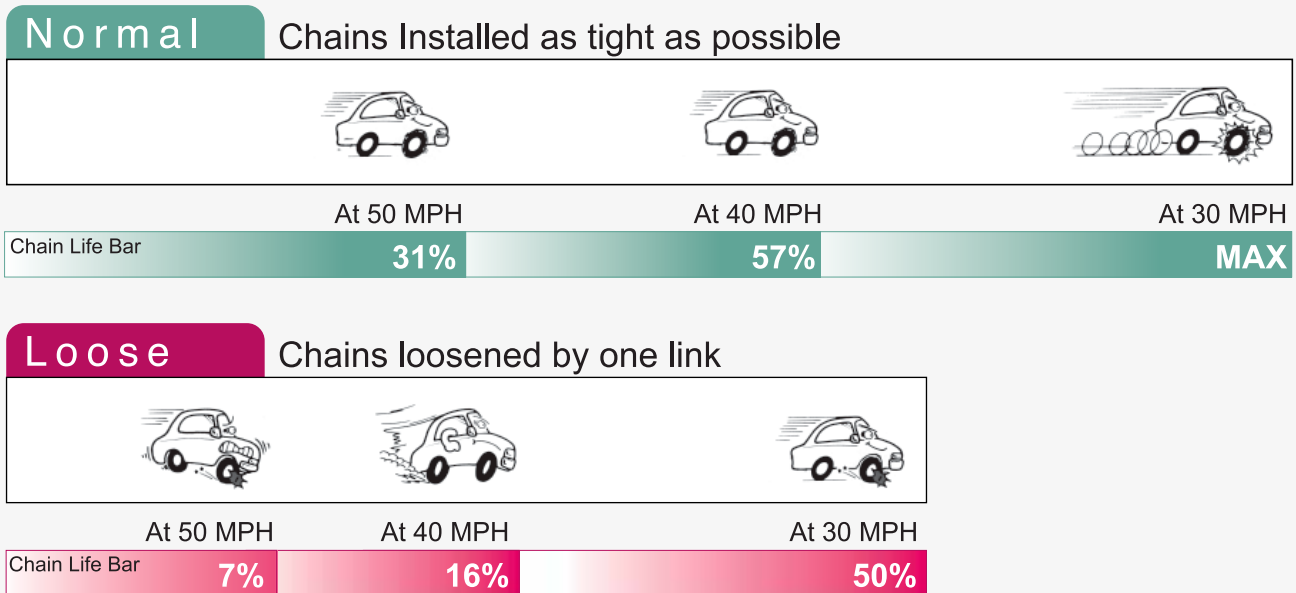



Other Winter Items



IS - 04



**Ice Scraper**

- With soft foam handle
- Easy to carry
- Clip board Packaged



IS - 05

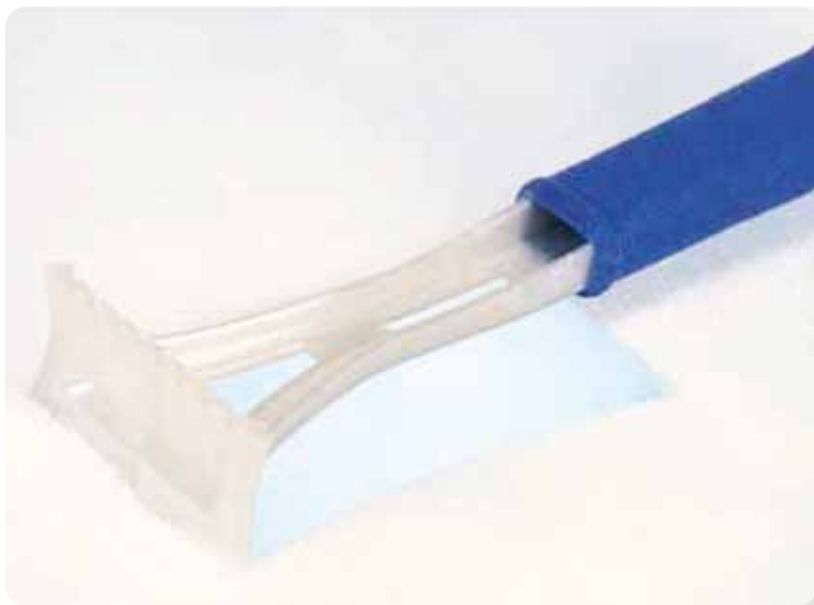

**Ice Scraper**

- With longer soft
- foam handle
- Easy to carry
- Clip board Packaged

